



FEDERATION INTERNATIONALE
DE L'AUTOMOBILE

JAPAN AUTOMOBILE FEDERATION
社団法人 日本自動車連盟

Gruppe / Group / グループ

N

Homologation N°

N-5714

Extension N°

09/05 VO

NON VALABLE EN SUPER PRODUCTION
NOT VALID IN SUPER PRODUCTION

JAF公認番号 **FN-085 VO-10/5**

JAF発効日 **2009年3月1日**

FICHE D'EXTENSION D'HOMOLOGATION
HOMOLOGATION EXTENSION FORM

追加公認書式

- | | | | |
|------------------------------------|---|---|--|
| <input type="checkbox"/> ES | Evolution sportive du type / Sporting evolution of the type
スポーツ進化 | <input checked="" type="checkbox"/> VO | Variante option / Option variant
オプション変型 |
| <input type="checkbox"/> ET | Evolution normale du type / Normal evolution of the type
型式の正常進化 | <input type="checkbox"/> VP | Variante de Production / Production variant
生産オプション変型 |
| <input type="checkbox"/> VF | Variante de fourniture / Supply variant
供給変型 | <input type="checkbox"/> ER | Erratum / Erratum
誤記訂正 |

Véhicule : Constructeur

Vehicle : Manufacturer

車両 : 製造会社名

FUJI HEAVY INDUSTRIES LTD.

Modèle et type

Model and type

モデルと型式

SUBARU IMPREZA WRX STI (2007), GRB

Homologation valable à partir du

Homologation valid as from

FIA公認発効年月日

01 MARS 2009

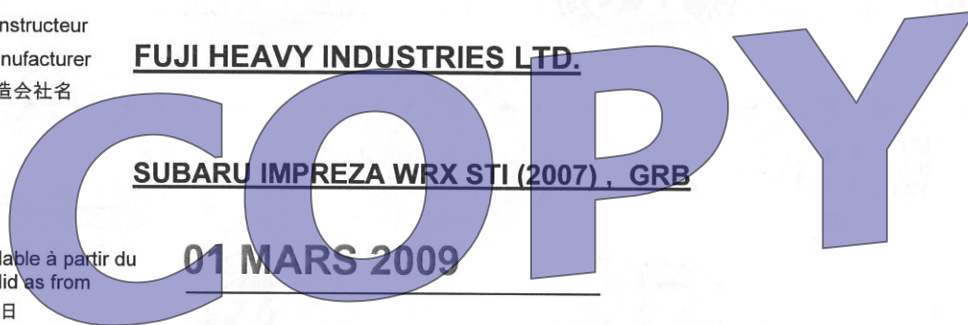

Page or ext. 頁または追加番号	Article 項目	Description 記述
	3 334	<p>ENGINE TURBO CHARGING <u>Original model :</u> <u>Homologation No.A/N-5695 01/01VP with Homologation No.A/N-5695 13/02VF</u></p> <p>INTERCOOLER WATER SPRAY SYSTEM</p> <p>Photo 0902301) Intercooler spray kit Drawing 0902901) Intercooler spray system Water tank location : between the crew and the rear suspension top mount System is not connected to the ECU</p> <p>Photo 0902302) Water tank mounting example - behind the seat, LH - Brackets may vary Photo 0902303) Water tank mounting example - behind the seat, RH - Brackets may vary Photo 0902304) Water tank mounting example - beside rear door, LH - Brackets may vary Photo 0902305) Water tank mounting example - beside rear door, RH - Brackets may vary</p> <p>RESTRICTOR</p> <p>Photo 0902306) Restrictor & duct assembly, type 3N Photo 0902307) Disassembled parts, type 3N Elbow turbo charger : Part number "C2/J2/009" Restrictor : Part number "N12/J2/001"</p>



Federation Internationale de l'Automobile
Chemin de Blandonnet, 2
CH-1215 GENEVE 15
Tél.: +41 22 544 44 00
Fax Sport: +41 22 544 44 50

Marque
Make
会社名 FUJI

Modèle
Model
行名 GRB

Homologation N°

N-5714

Extension N°

09/05 VO

JAF公認番号

FN-085 VO-10/5

PHOTO N° 0902301

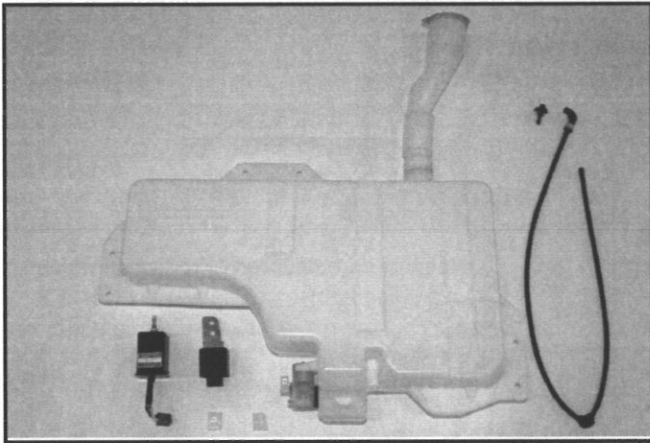

The parts included in the kit

- INT. TIMER UNIT
- TIMER UNIT
- CONNECTOR FOR THE TIMER UNIT
- WATER TANK (Tank Capacity 12.6± 1Litre)
- WATER PUMP
- CONNECTOR FOR THE WATER PUMP
- ONEWAY VALVE with HOSE
- SPLAY NOZZLE

DRAWING N° 0902901

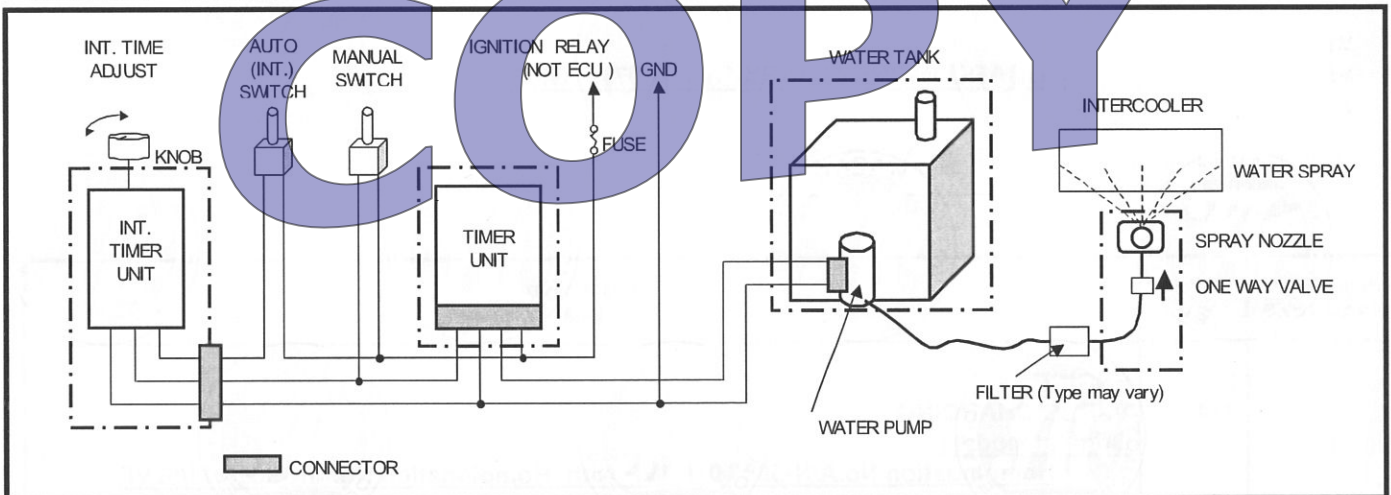

PHOTO N° 0902302

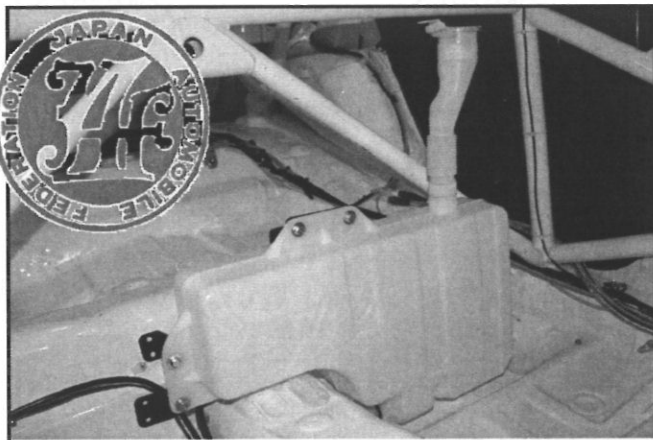
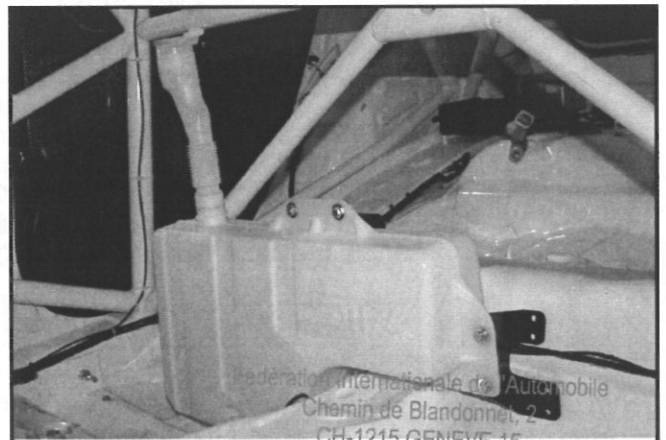

PHOTO N° 0902303



Fédération Internationale de l'Automobile
Chemin de Blandonnet, 2
CH-1215 GENEVE 16
Tél.: 41 22 544 44 00
Fax Sport: 41 22 544 44 50

Marque
Make
会社名 FUJI

Modèle
Model
行名 GRB

Homologation N°

N-5714

Extension N°

09/05 VO

JAF公認番号

FN-085 VO-10/5

PHOTO N° 0902304

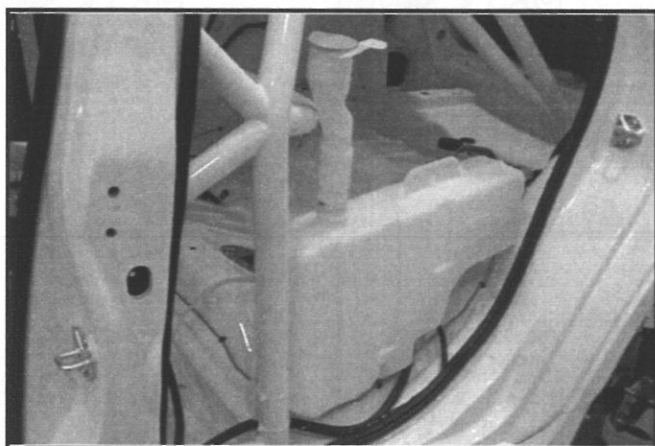

PHOTO N° 0902305



PHOTO N° 0902306

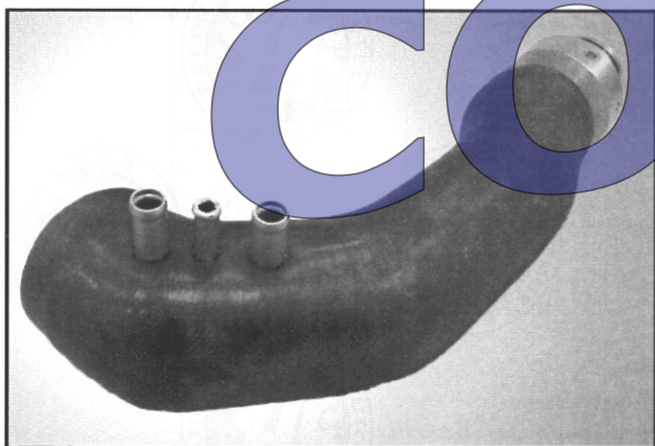

PHOTO N° 0902307

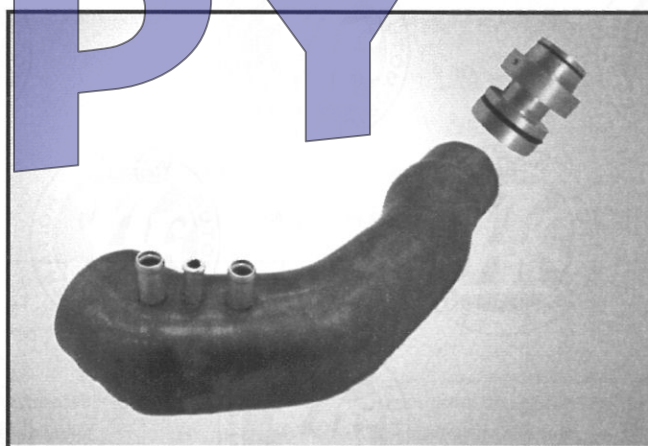

PHOTO N°

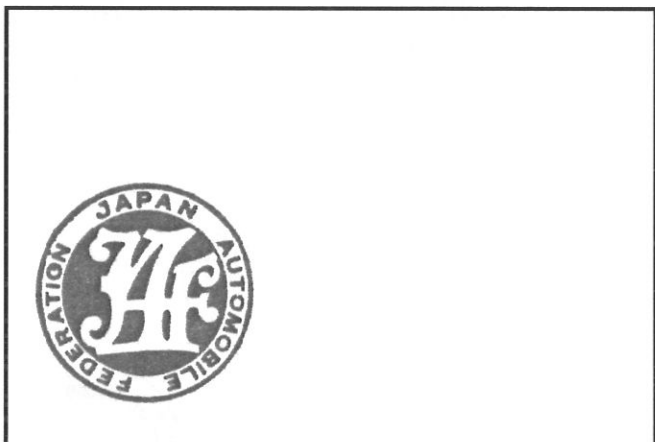
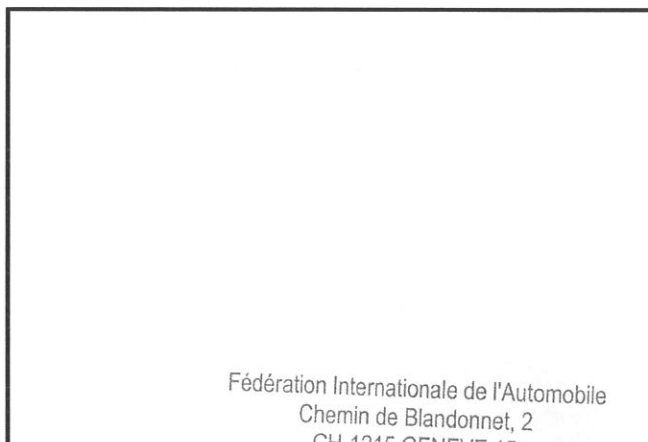

PHOTO N°



Fédération Internationale de l'Automobile
Chemin de Blandonnet, 2
CH 1216 GENEVE 15
Tél.: 41 22 544 44 00
Fax Sport: 41 22 544 44 50

Marque
Make
会社名 FUJI

Modèle
Model
モデル GRB

Homologation N°

N-5714

Extension N°

09/05 VO

JAF公認番号

FN-085 VO-10/5

334. Suralimentation
Turbocharging
ターボチャージャー

b) Carter de turbine
Turbine housing タービンハウジング

a) Marque et type du turbocompresseur
Make and type of the turbocharger **IHI , RH**
ターボチャージャーの製造会社名と型式

b1) Nombre d'entrées des gaz d'échappement
Number of exhaust gas entries 排気取り入れ口の数 **2**

b2) Matériau
Material 材質 **CAST-IRON**

c) Roue de turbine
Turbine wheel タービンホイール

c1) Matériau
Material 材質 **STEEL**

c2) Nombre d'aubes
Number of blades **11**
ブレードの数

c3) Hauteur(s) des aubes
Height(s) of blades **22.8** +/- 0.5 mm
ブレードの高さ

c4) Cotes A, B, C, selon le schéma suivant
Dimensions A, B, C, according to the following sketch
右図のA,B,Cの寸法

A = **49.1** +/- 0.4 mm

B = **9.4** +/- 0.5 mm

C = **53.0** +/- 0.3 mm (When it is new)

C = **53.4** +/- 0.3 mm (When it is after used)

c5) Aubes variables
Variable blades 可変ブレード

oui
yes 有

non
no 無

d) Carter de compression
Impeller housing インペラハウジング

d1) Nombre d'entrées d'air (mélange)
Number of air entries (gas) 空気取り入れ口の数 **1**

d2) Matériau
Material 材質 **ALUMINIUM ALLOY**

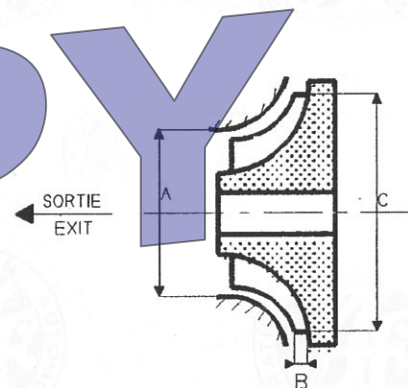

Fédération Internationale de l'Automobile
Chemin de Blandonnet, 2
CH-1215 GENEVE 15
Tél.: 41 22 544 44 00
Fax Sport: 41 22 544 44 50

Marque
Make
会社名 FUJI

Modèle
Model
モデル GRB

Homologation N°

N-5714

Extension N°

09/05 VO

JAF公認番号

FN-085 VO-10/5

e) Roue de compression
Impeller wheel インパeller

e1) Matériau
Material 材質 **ALUMINIUM ALLOY**

e2) Nombre d'aubes
Number of blades **12**
ブレードの数

e3) Hauteur(s) des aubes
Height(s) of blades **6 blades of 24.1 +/- 0.5 mm
and 6 blades of 14.1 +/- 0.5 mm**
ブレードの高さ

e4) Cotes A, B, C, selon le schéma suivant
Dimensions A, B, C, according to the following sketch
右図のA,B,Cの寸法

A = **47.1** +/- 0.4 mm
B = **5.6** +/- 0.5 mm
C = **60.0** +/- 0.4 mm

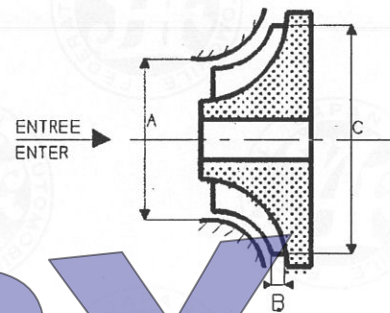

e5) Aubes variables
Variable blades 可変ブレード

<input type="checkbox"/> oui yes 有	<input checked="" type="checkbox"/> non no 無
---------------------------------------	---

f) Régulation de la pression
Pressure regulation 圧力調整

f1) Type de régulation de la pression :
Type of pressure adjustment :
圧力調整の方式

<input type="checkbox"/> by-pass バイパス	<input checked="" type="checkbox"/> soupape de décharge relief valve リリーフバルブ	<input type="checkbox"/> autre cas other case その他
--	--	---

f2) Type de la soupape
Type of the valve **DIAPHRAGM**
バルブの形式

g) Système d'échappement
Exhaust system 排気方式

g1) Dimensions intérieures de(s) éventuel(s) tuyau(x) d'échappement entre collecteur d'échappement et turbocompresseur / Internal dimensions of the possible exhaust pipe(s) between exhaust manifold and turbocharger **xxx** mm
エキゾーストマニホールドとターボの間エキゾーストパイプの内径

h) Refroidissement de l'air d'admission
Cooling of the intake air 吸気冷却

h1) oui
yes 有 non
no 無

h2) Système
System 方式 air/air
air/air 空気/空気 air/eau
air/water 空気/水 simple-passe
single-flow 単流 double-passe
double-flow 複流

Capacité en eau
Water capacity 水の容量 **xxx** l

h3) Diamètre de l'entrée d'air
Air inlet diameter **60** +/-1 mm X2
吸気口径

h4) Diamètre de la sortie d'air
Air outlet diameter **65** +/-1 mm
排気口径



Fédération Internationale de l'Automobile
Chemin de Blandonnet, 2
CH-1215 GENEVE 15
Tél.: 41 22 544 44 00
Fax Sport: 41 22 544 44 50

Marque
Make
会社名 FUJI

Modèle
Model
行名 GRB

Homologation N°

N-5714

Extension N°

09/05 VO

JAF公認番号

FN-085 VO-10/5

PHOTOS / PHOTOS / 写真

K) Vue de dessus du turbocompresseur
Plan view of turbocharger ターボチャージャーの上面視

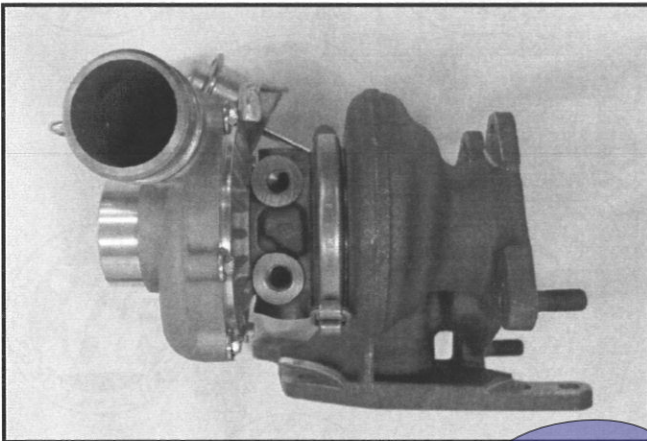

L) Vue de face du turbocompresseur
Front view of turbocharger ターボチャージャーの前面視

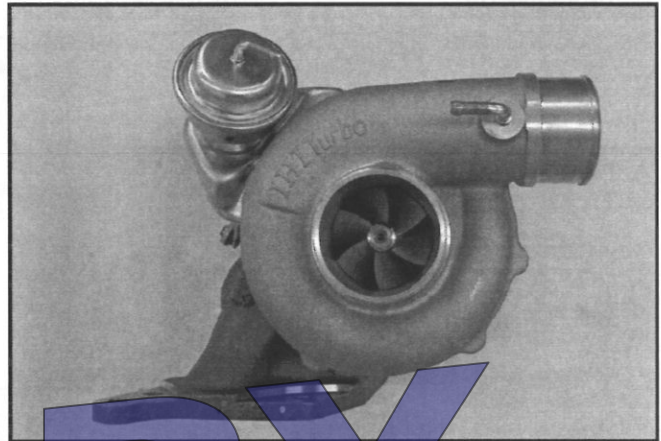

M) Vue de côté du turbocompresseur
Side view of turbocharger ターボチャージャーの側面視

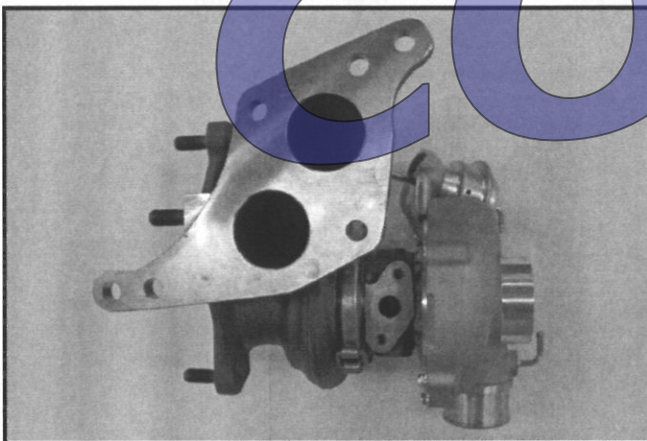

N) Carter de turbine du turbocompresseur
Turbine housing of turbocharger ターボチャージャーのタービンハウジング

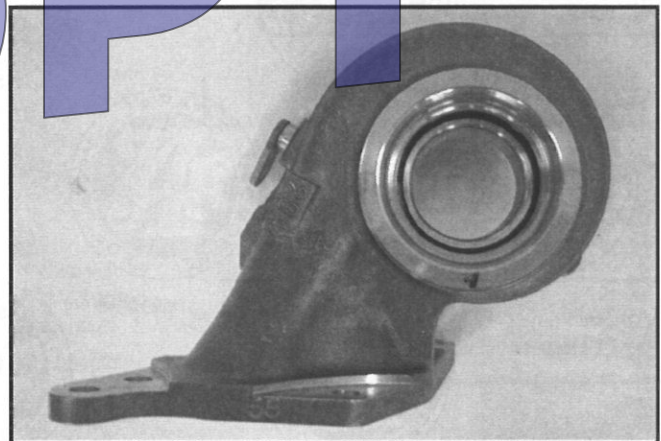

O) Soupape et montage du by-pass du turbocompresseur
Valve and by-pass installation of turbocharger
バルブとバイパスのターボチャージャーへの取付位置

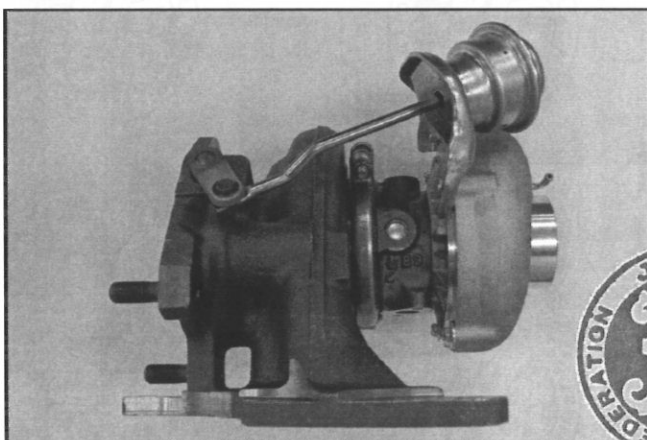

P) Système d'échappement entre collecteur et turbocompresseur
Exhaust system between manifold and turbocharger
ターボコンプレッサーとマニホールド間の排気方式

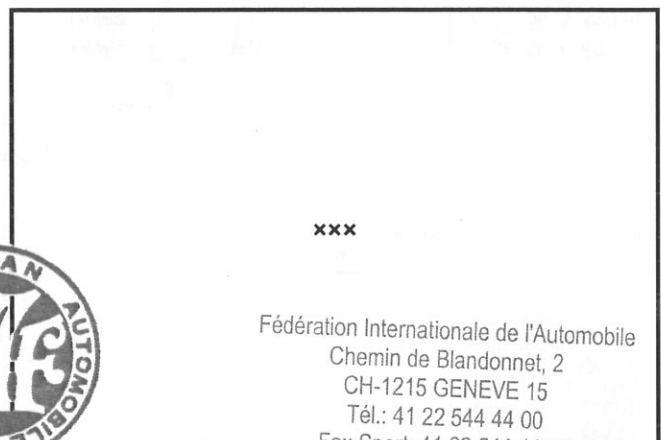

xxx

Fédération Internationale de l'Automobile
Chemin de Blandonnet, 2
CH-1215 GENEVE 15
Tél.: 41 22 544 44 00
Fax Sport: 41 22 544 44 50



Marque
Make
会社名 FUJI

Modèle
Model
モデル GRB

Homologation N°

N-5714

Extension N°

09/05 VO

JAF公認番号

FN-085 VO-10/5

- Q) Carter de compression du turbocompresseur
Compressor housing of turbocharger ターボチャージャーのコンプレッサハウジング

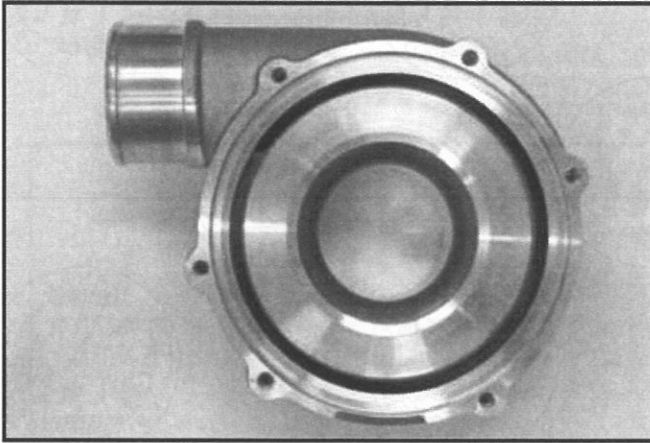

- R) Echangeur intermédiaire déposé
Intercooler dismounted 取り外したインタークーラー

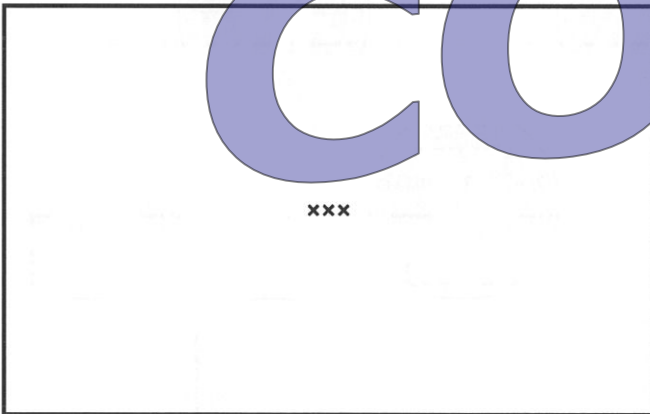

- Z) Echangeur intermédiaire monté
Intercooler mounted 取り付けしたインタークーラー

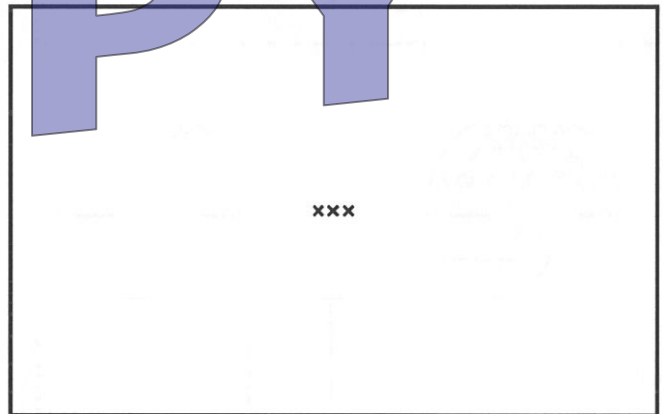

Dessin de l'échangeur avec dimensions
Drawing of the intercooler with dimensions 寸法を伴ったインタークーラーの図



Fédération Internationale de l'Automobile
Chemin de Blandonnet, 2
CH-1215 GENEVE 15
Tél.: 41 22 544 44 00
Fax Sport: 41 22 544 44 50

Marque
Make
会社名 FUJI

Modèle
Model
型名 GRB

Homologation N°

N-5714

Extension N°

09/05 VO

JAF公認番号

FN-085 VO-10/5

DESSINS / DRAWINGS / 図解

- V) Entrée des gaz d'échappement dans turbine de compresseur
Exhaust gas inlet to the compressor turbine
ターボチャージャコンプレッサの排気入口図

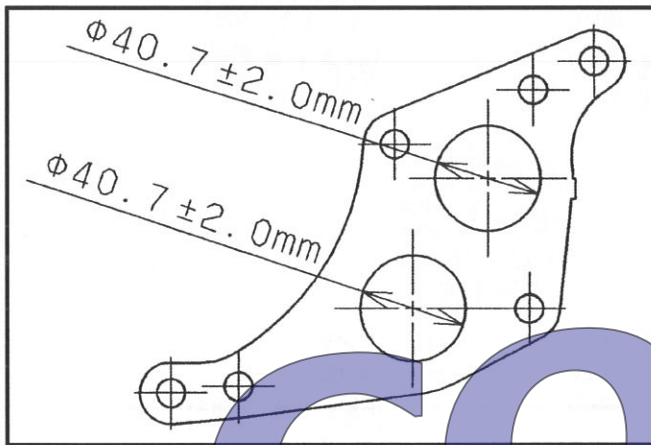

- VI) Sortie des gaz d'échappement de turbine de compresseur
Exhaust gas outlet from the compressor turbine
ターボチャージャコンプレッサの排気出口図

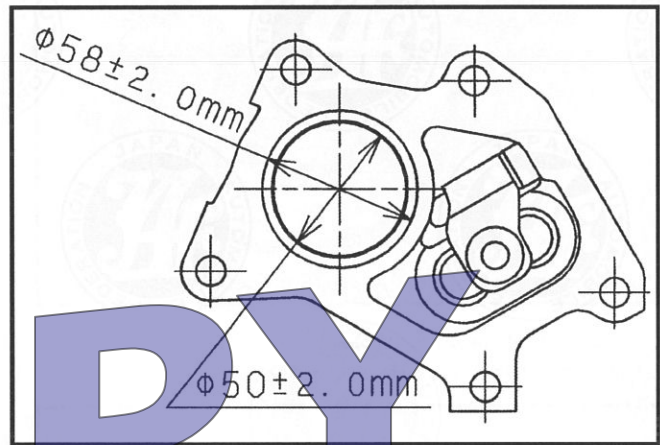

- VII) Entrée d'air (mélange) dans carter de compresseur
Air (gas) inlet to the compressor housing
コンプレッサハウジングの入口図

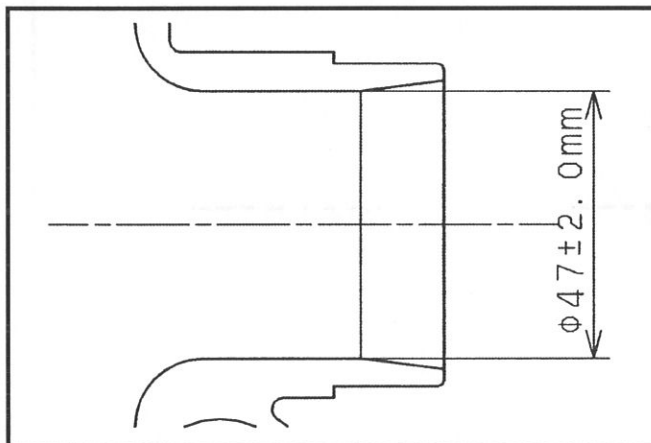

- VIII) Sortie d'air (mélange) du carter de compresseur
Air (gas) outlet from the compressor housing
コンプレッサハウジングの出口図

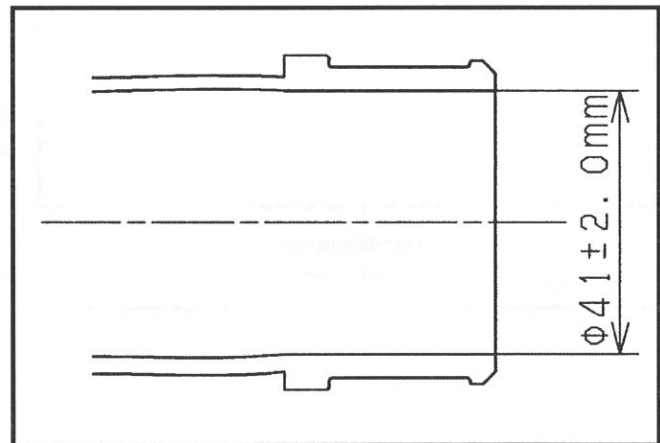

Fédération Internationale de l'Automobile
Chemin de Blandonnet, 2
CH-1215 GENEVE 15
Tél.: 41 22 544 44 00
Fax Sport: 41 22 544 44 50

Marque
Make
会社名 FUJI

Modèle
Model
行名 GRB

Homologation N°

N-5714

Extension N°

09/05 VO

JAF公認番号

FN-085 VO-10/5

IX) DISPOSITIF REGLANT LA PRESSION DE SURALIMENTATION
DEVICE REGULATING THE TURBOCHARGER PRESSURE 過給圧力の調整装置図

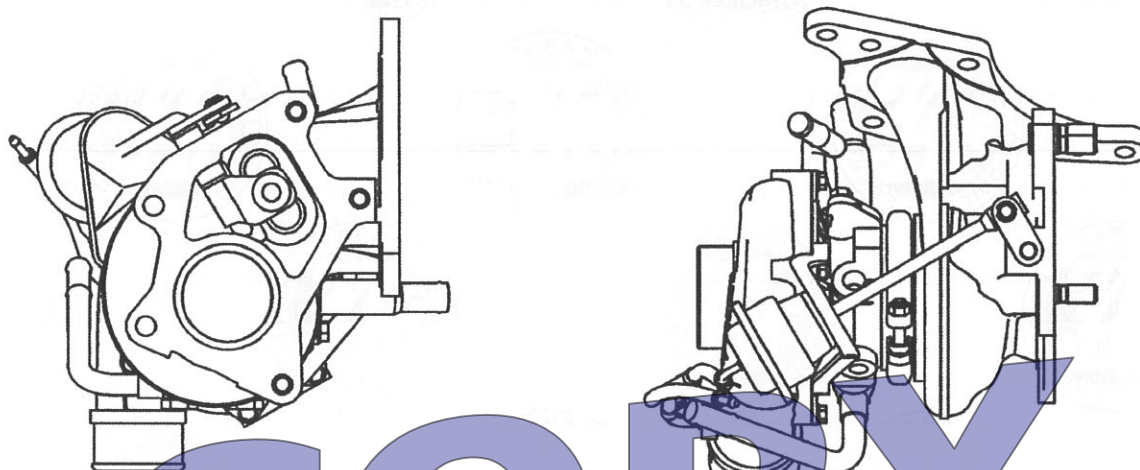

Pression standard

Standard pressure 0.85 ± 0.08 bar

標準過給圧力

Procédure de contrôle de la pression

Procedure for checking the pressure PRESSURE CORRESPONDING TO AN

過給圧力の検査手順

AXIAL DISPLACEMENT OF THE WASTE GATE CONTROL ROD OF 6.0mm

XV) SYSTEME DE REFROIDISSEMENT DE L'INTERCOOLER
INTERCOOLER COOLING SYSTEM インタークーラーの冷却方式図

xxx



Fédération Internationale de l'Automobile
Chemin de Blandonnet, 2
CH-1215 GENEVE 15
Tél.: 41 22 544 44 00
Fax Sport: 41 22 544 44 50



FEDERATION INTERNATIONALE
DE L'AUTOMOBILE

JAPAN AUTOMOBILE FEDERATION

社団法人 日本自動車連盟

Groupe / Group / グループ

N

Homologation N°

N-5714

Extension N°

10/05 ER

NON VALABLE EN SUPER PRODUCTION
NOT VALID IN SUPER PRODUCTION

JAF公認番号 **FN-085 ER-11/5**

JAF発効日 **2009年3月1日**

FICHE D'EXTENSION D'HOMOLOGATION
HOMOLOGATION EXTENSION FORM

追加公認書式

- | | | | |
|------------------------------------|---|---|--|
| <input type="checkbox"/> ES | Evolution sportive du type / Sporting evolution of the type
スポーツ進化 | <input type="checkbox"/> VO | Variante option / Option variant
オプション変型 |
| <input type="checkbox"/> ET | Evolution normale du type / Normal evolution of the type
型式の正常進化 | <input type="checkbox"/> VP | Variante de Production / Production variant
生産オプション変型 |
| <input type="checkbox"/> VF | Variante de fourniture / Supply variant
供給変型 | <input checked="" type="checkbox"/> ER | Erratum / Erratum
誤記訂正 |

Véhicule : Constructeur

Vehicle : Manufacturer

車両 : 製造会社名

FUJI HEAVY INDUSTRIES LTD.

Modèle et type

Model and type

モデルと型式

SUBARU IMPREZA WRX STI (2007) , GRB

Homologation valable à partir du

Homologation valid as from

FIA公認発効年月日

01 MARS 2009

COPY

Page or ext. 頁または追加番号	Article 項目	Description 記述
08/04VO	9	BODY WORK Removable unused supports (Any other parts than parts listed on page 2 and 3 may not be removed)



Fédération Internationale de l'Automobile
Chemin de Blandonnet, 2
CH-1215 GENEVE 15
Tél.: +41 22 544 44 00
Fax Sport: +41 22 544 44 50

Marque
Make
会社名 **FUJI**

Modèle
Model
行名 **GRB**

Homologation N°

N-5714

Extension N°

10/05 ER

JAF公認番号

FN-085 ER-11/5

Page or ext. 頁または追加番号	Article 項目	Description 記述				
		Photo No	PART NAME	PART No	FOR	MASS (kg)
		0902311_1 / 2 / 3	HOOK TIE DOWN	51681AG000	TIE DOWN	(0.237kax 2) 0.474
		0902312_1 / 2	COVER COMPL T/B RHD	52240AG000	NOISE & HEAT PROTECTION	0.507
		0902313_1 / 3	STAY CP COWL SD LH	50866FG050		0.408
		0902313_1 / 3	PILOT BOLT	- 010110200	SUPPORT	(0.020kax 4) 0.080
		0902313_2 / 3	STAY CP COWL SD RH	50866FG040		0.404
		0902313_2 / 3	PILOT BOLT	- 010110200		(0.020kax 4) 0.080
		0902314_1 / 2	PLATE COMPL	35038AG081	RUBBER BOOTS	0.387
		0902315_1 / 2	CROSS MBR F/ S F C LH	52140AG180		0.910
		0902315_1 / 2	CROSS MBR FS R CP LH	52140AG210	SEAT MOUNTING	0.764
		0902316_1 / 2	CROSS MBR F/ S F C RH	52140AG160	(It may removed only when replaced by welded seat mountings)	0.938
		0902316_1 / 2	CROSS MBR FS R CP RH	52140AG200		0.762
		0902317_1 / 2	BRACE A	53701FG010	SUPPORT	0.238
		0902317_1 / 2	BRACE B	53701FG020	SUPPORT	0.234
		0902318_1 / 3	BRKT HARNESS LH	52152AG030		0.064
		0902318_2 / 3	BRKT HARNESS RH	52152AG020	WIRING HARNESS	0.064
		0902318_1 / 2 / 3	FLANGE BOLT	- 10108160		(0.012kax 4) 0.048
		0902319_1 / 2	BRKT SENSOR	20172FG100	SENSOR	0.066
		0902320_1 / 3	PLR COMPL CTR IN LH	51530FG010	SEAT BELT	
					(It may be Removed only when the original seat belt is replaced by FIA homologated type)	0.044
		0902320_2 / 3	PLR COMPL CTR IN RH	51530FG000		0.046
		0902321_1 / 2	BRKT H/ B CABLE	52153AG380	HAND BRAKE CABLE	
					(It may be Removed only when the original hand brake system is replaced by FIA homologated hydraulic hand brake)	0.022
		0902322_1 / 3	BRKT HAND B CBL R LH	52152FG120		0.042
		0902322_2 / 3	BRKT HAND B CBL R RH	52152FG110		0.042
		0902323_1 / 2	COVER CANISTER LH	42054FG010	CANISTER COVER	1.324
		0902323_1 / 2	COVER CANISTER RH	42054FG000		1.484
		0902323_1 / 2	COVER CANISTER CTR	42054FG020		0.362
		0902323_1 / 2	BOLT	- 010108160		(0.020kax 4) 0.080
		0902323_1 / 2	NUT	- 023808000		(0.012kax 4) 0.048
		0902324_1 / 2	GUSSET R APRON LH	52163FG010	SUPPORT	0.541
		0902325_1 / 2	GUSSET R APRON RH	52163FG000		0.521
		0902326_1 / 2	BRKT COV EXH R CP	52153AB030	FUEL FILLER PIPE	0.010
		0902327_1 / 2	BRKT TRACTIVE CP	57803FG000	TOEING	1.242
		0902327_1 / 2	NUT	- 902370042		(0.012kax 3) 0.036
		0902328_1 / 2	PLATE SKIRT LH	52432FG030	COVER	0.082
		0902329_1 / 2	PLATE SKIRT RH	52432FG020		0.082
		0902329_1 / 2	NUT	- 902370042		(0.012kax 2) 0.024
		0902330_1 / 2	COVER EXH CP	59020FG010		0.777
		0902331_1 / 2	COVER FUEL TANK CP	42054FG080	HEAT PROTECTION	0.343
		0902332_1 / 2	COVER EXH R	59024FG020		0.413
					SUB TOTAL	13.993
					TOTAL	16.673

Fédération Internationale de l'Automobile
Chemin de Diancourmet, 2
CH-1215 GENEVE 4

Tél.: 41 22 544 44 00
Fax Sport: 41 22 544 44 50



Marque
Make
会社名 **FUJI**

Modèle
Model
行名 **GRB**

Homologation N°

N-5714

Extension N°

10/05 ER

JAF公認番号

FN-085 ER-11/5

PHOTO N° 0805301_1

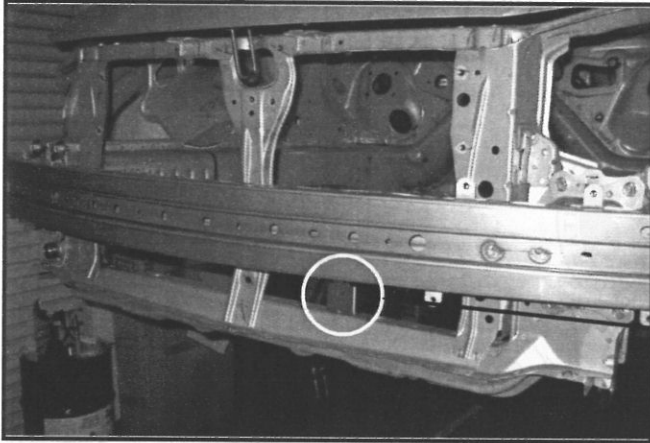

PHOTO N° 0805301_2

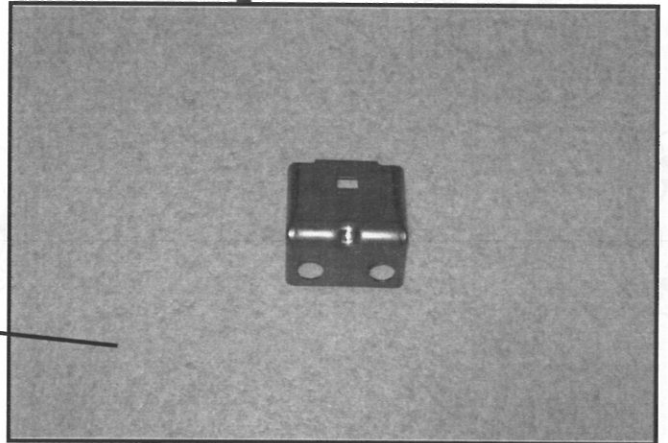

PHOTO N° 0805302_1

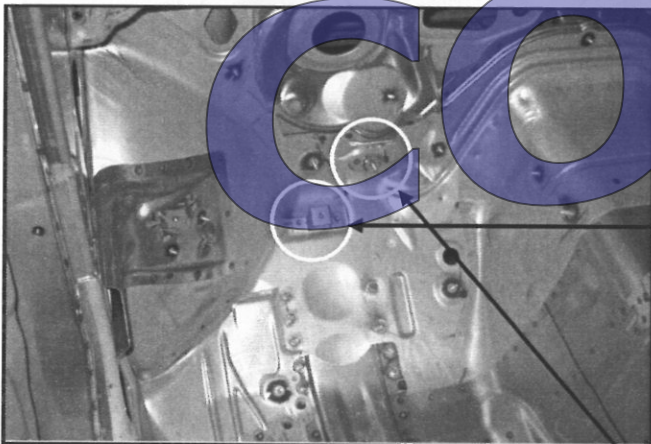

PHOTO N° 0805302_2

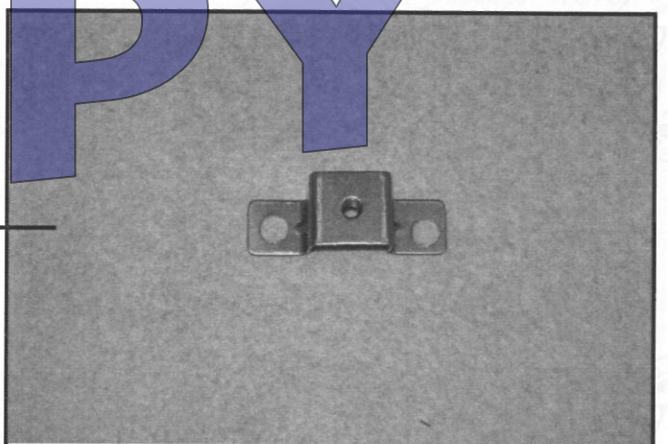

PHOTO N°

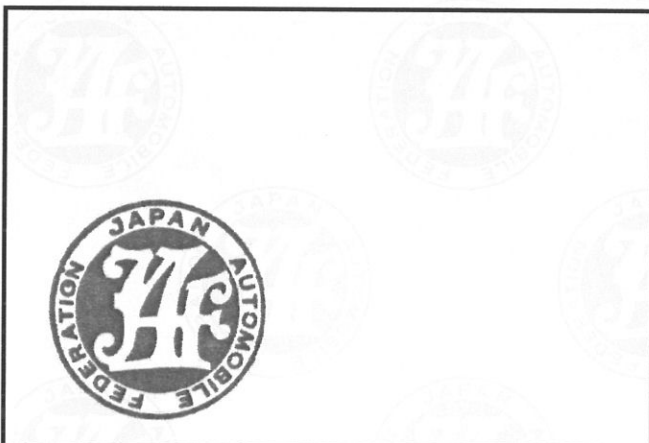
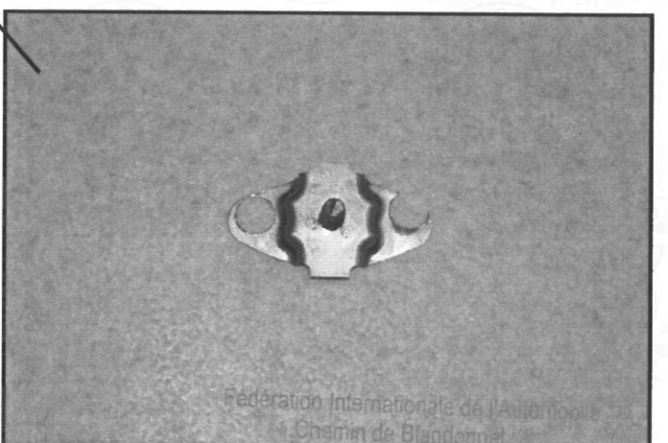

PHOTO N° 0805302_3



Fédération Internationale de l'Automobile
Chemin de Blandinnet, 2

CH-1215 GENEVE 15
Tél.: 41 22 544 44 00
Fax Sport: 41 22 544 44 50

Marque
Make
会社名 **FUJI**

Modèle
Model
行名 **GRB**

Homologation N°

N-5714

Extension N°

10/05 ER

JAF公認番号

FN-085 ER-11/5

PHOTO N° 0805303_1

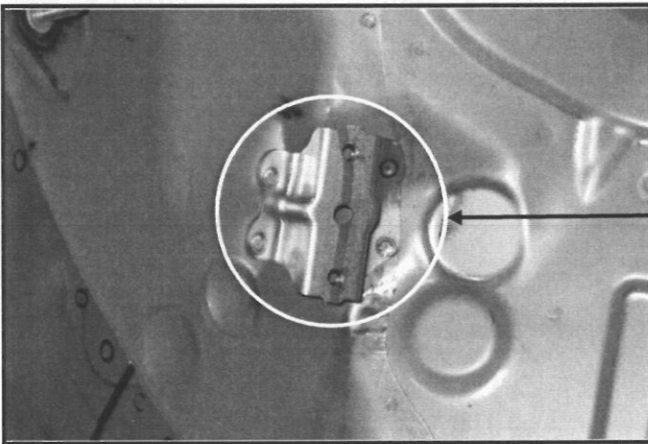

PHOTO N° 0805303_2

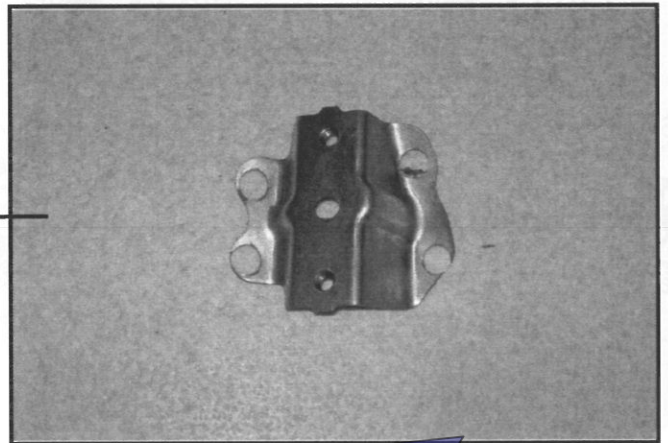

PHOTO N° 0805304_1

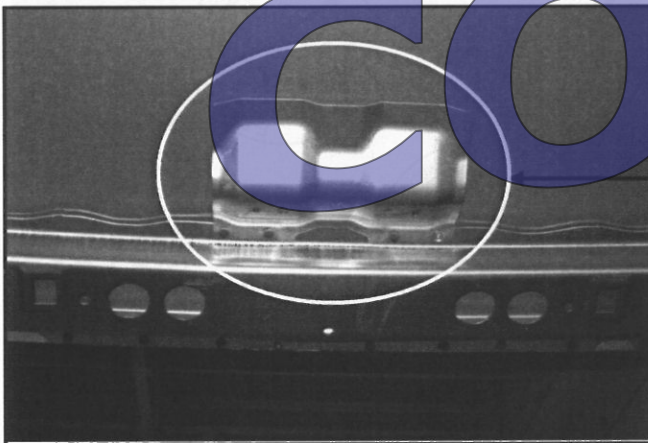

PHOTO N° 0805304_2

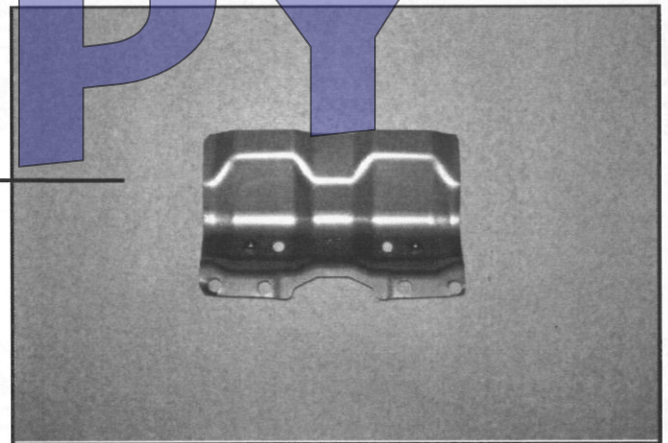

PHOTO N° 0805305_1

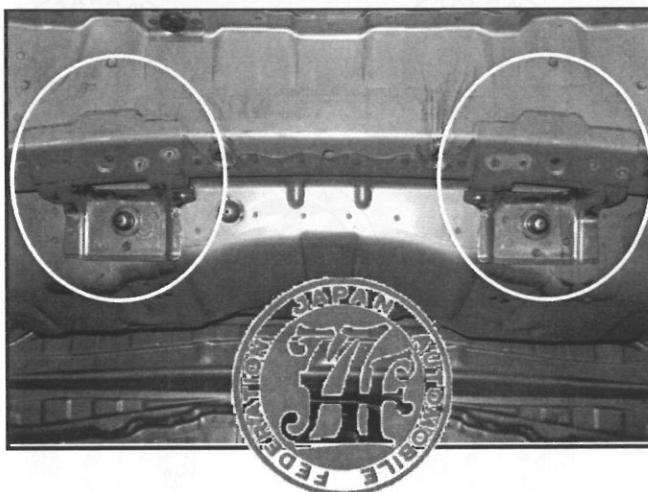
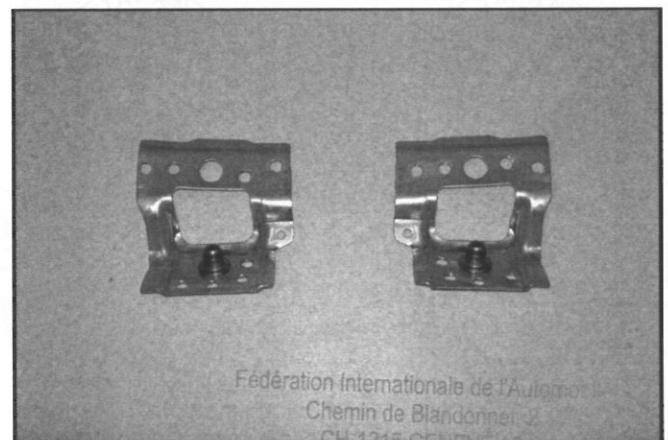

PHOTO N° 0805305_2



Fédération Internationale de l'Automobile
Chemin de Blandanet, 2
CH-1713 GENÈVE 18

Tél.: 41 22 544 44 00
Fax Sport: 41 22 544 44 50

Marque
Make
会社名 **FUJI**

Modèle
Model
行名 **GRB**

Homologation N°

N-5714

Extension N°

10/05 ER

JAF公認番号

FN-085 ER-11/5

PHOTO N° 0805306_1

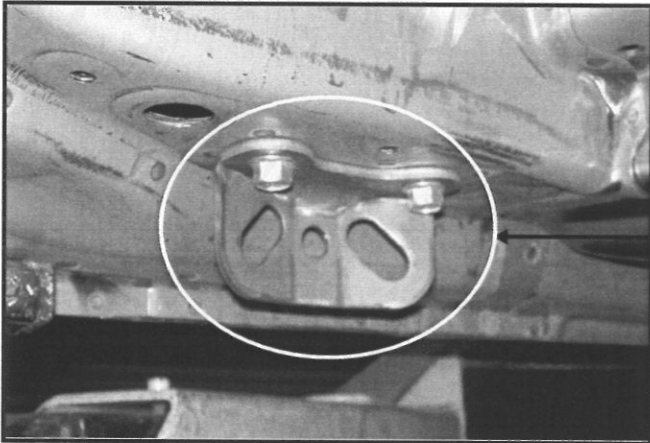

PHOTO N° 0805306_3

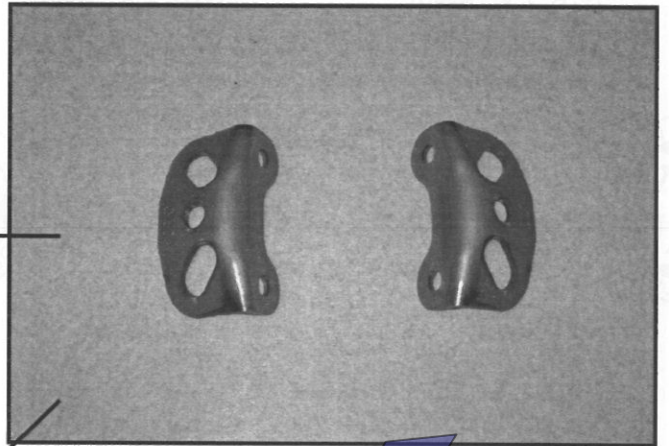

PHOTO N° 0805306-2

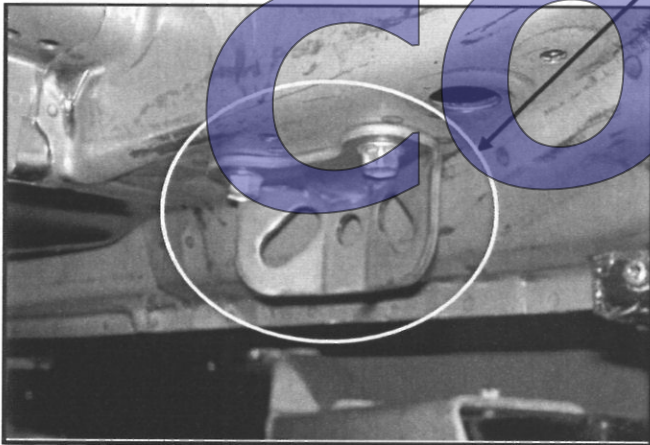

PHOTO N°

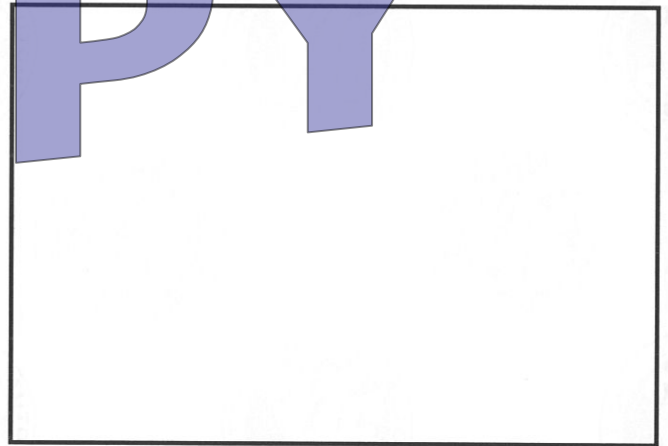

PHOTO N° 0805307_1

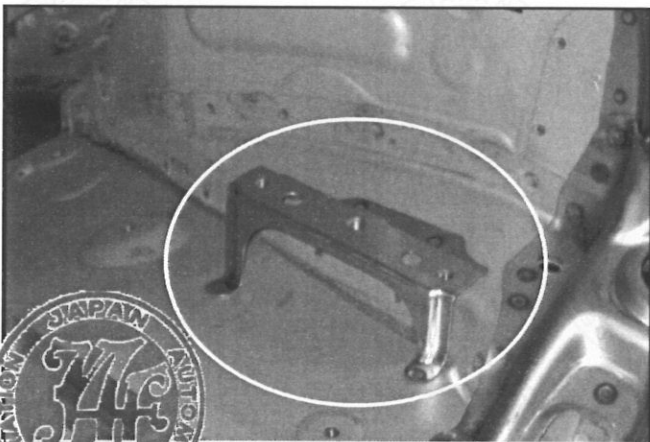
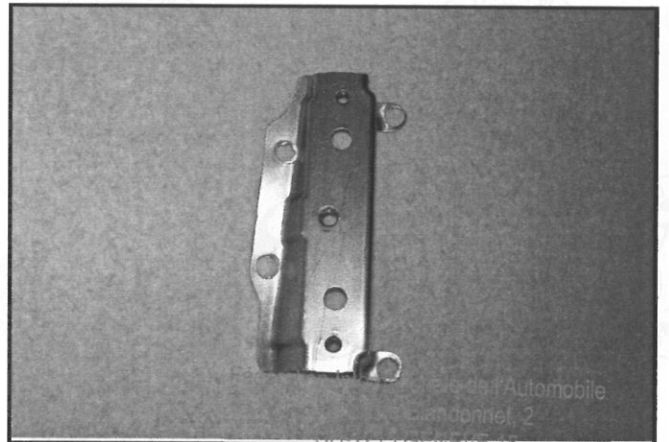

PHOTO N° 0805307_2



Marque
Make
会社名 **FUJI**

Modèle
Model
行名 **GRB**

Homologation N°

N-5714

Extension N°

10/05 ER

JAF公認番号

FN-085 ER-11/5

PHOTO N° 0805308_1

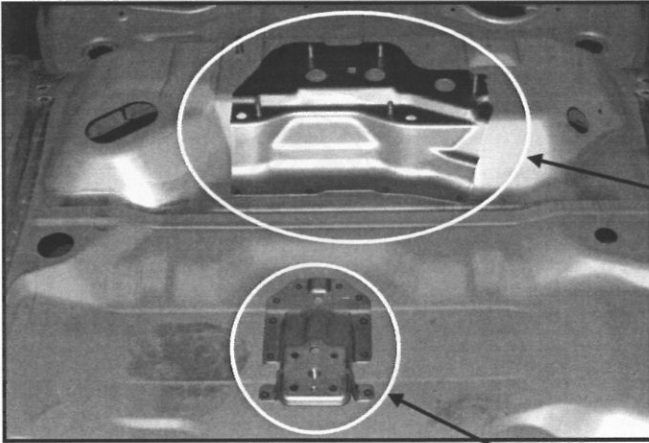

PHOTO N° 0805308_2

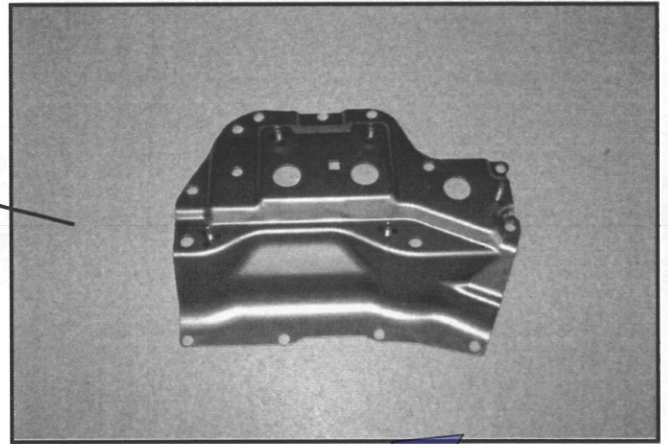

PHOTO N°

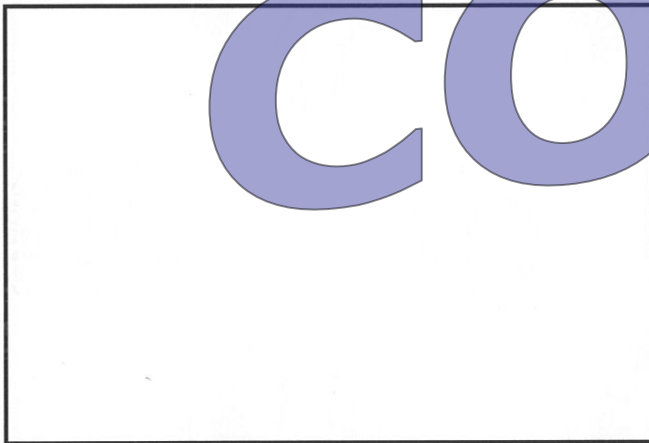

PHOTO N° 0805308_3

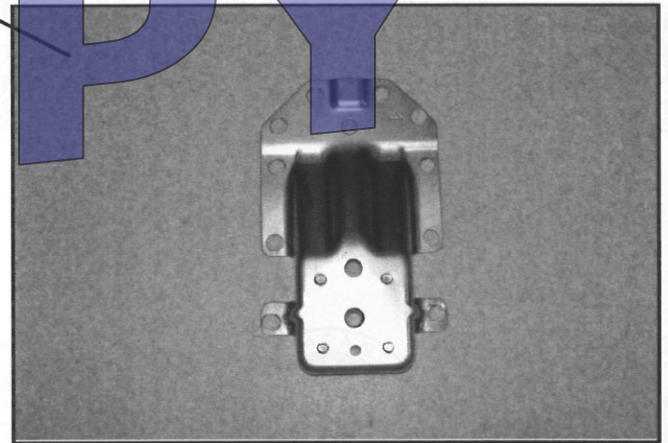

PHOTO N° 0805309_1

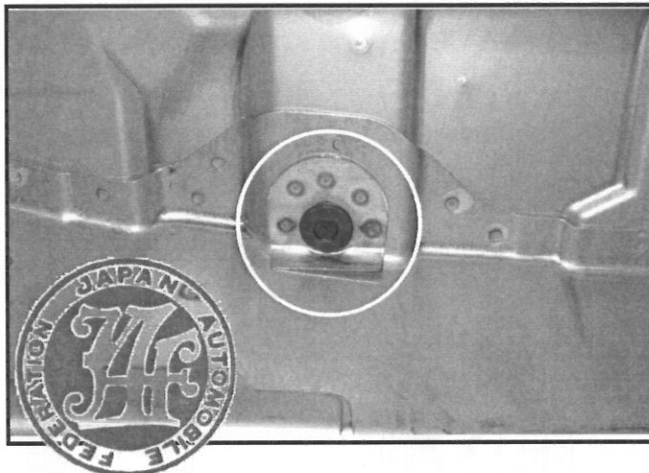
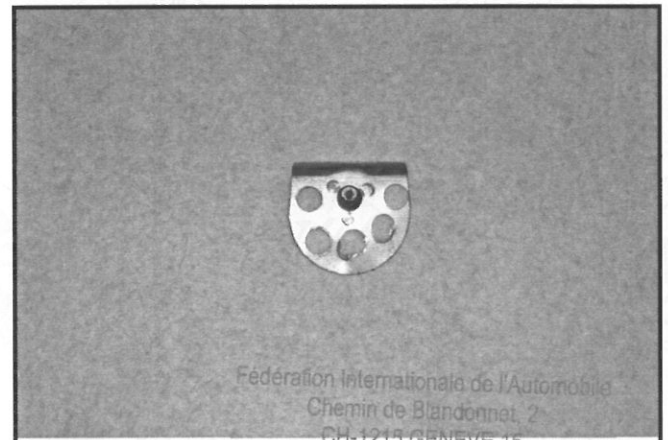

PHOTO N° 0805309_2



Fédération Internationale de l'Automobile
Chemin de Blandonnat, 2
CH-1213 GENEVE 18

Tél.: 41 22 544 44 00
Fax Sport: 41 22 544 44 50

Marque
Make
会社名 **FUJI**

Modèle
Model
型名 **GRB**

Homologation N°

N-5714

Extension N°

10/05 ER

JAF公認番号

FN-085 ER-11/5

PHOTO N° 0805310_1

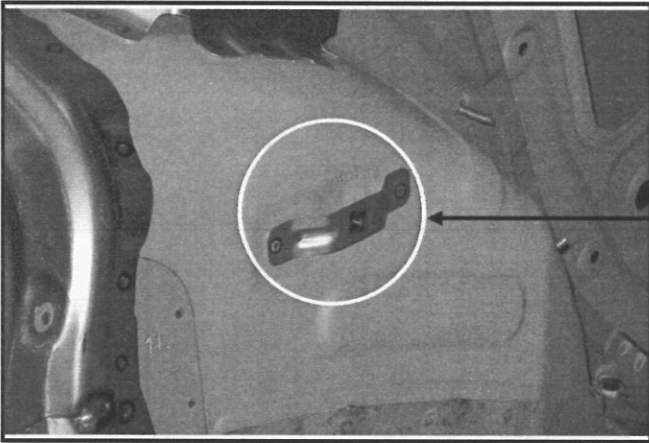

PHOTO N° 0805310_3

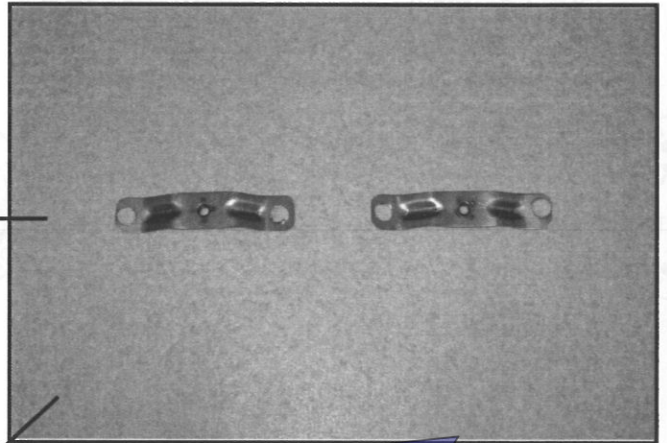

PHOTO N° 0805310_2



PHOTO N°

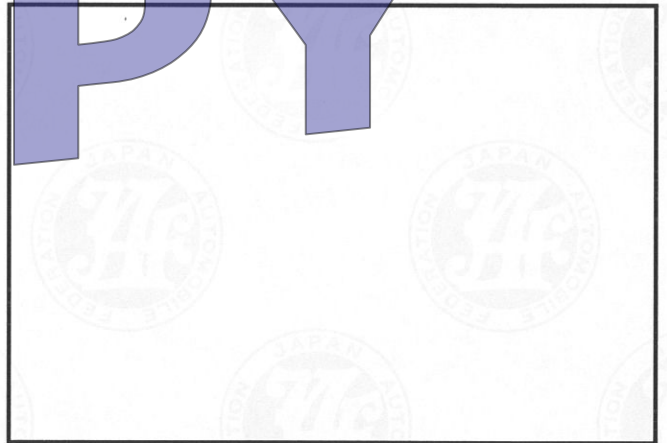

PHOTO N° 0805311_1

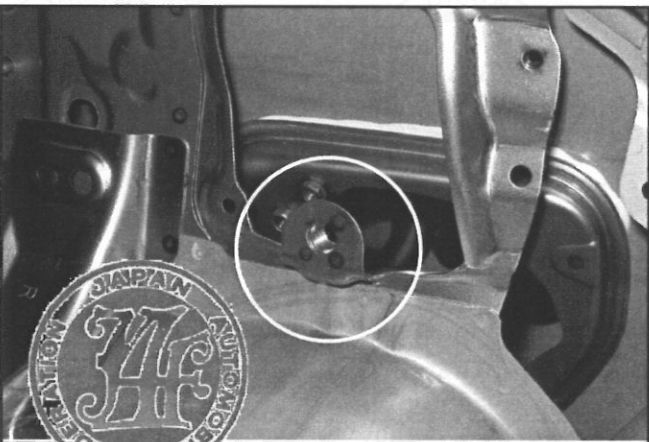
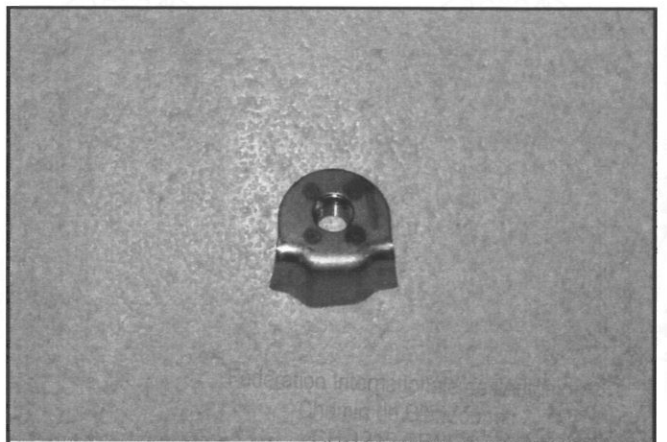

PHOTO N° 0805311_2



Tél.: 41 22 544 44 00
Fax Sport: 41 22 544 44 50

Marque
Make
会社名 FUJI

Modèle
Model
行名 GRB

Homologation N°

N-5714

Extension N°

10/05 ER

JAF公認番号

FN-085 ER-11/5

PHOTO N° 0805312_1

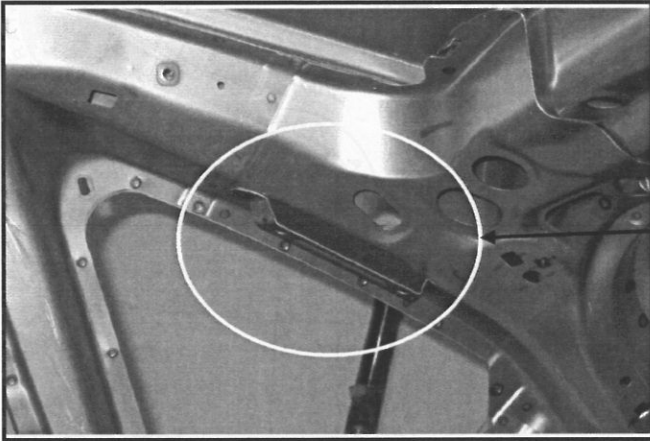

PHOTO N° 0805312_3

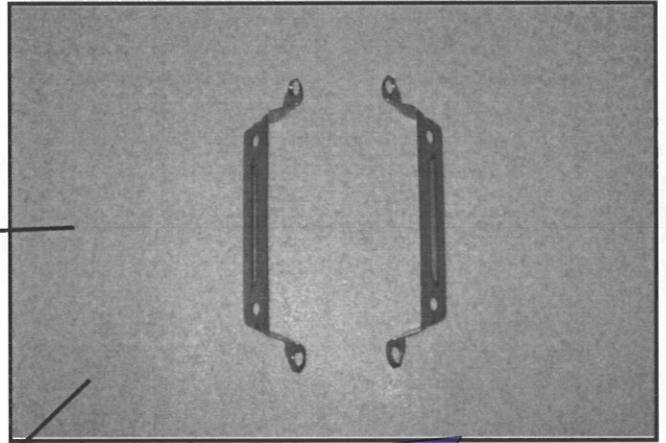

PHOTO N° 0805312_2

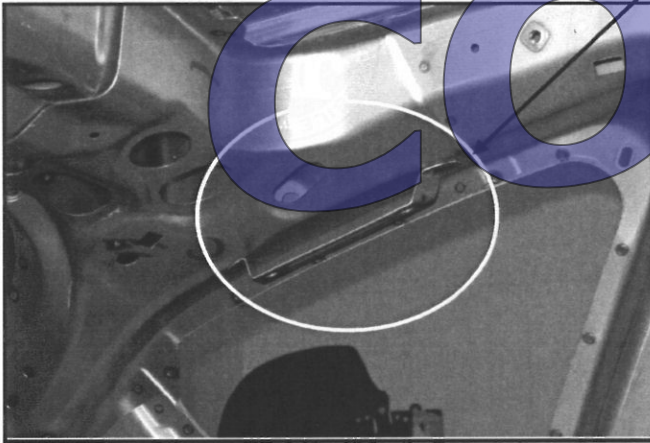

PHOTO N°

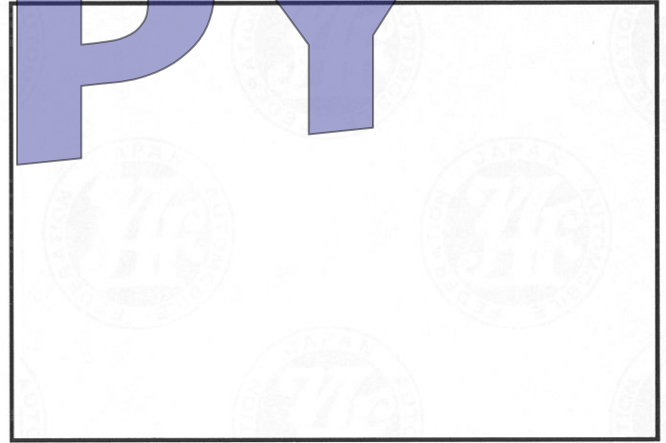

PHOTO N°

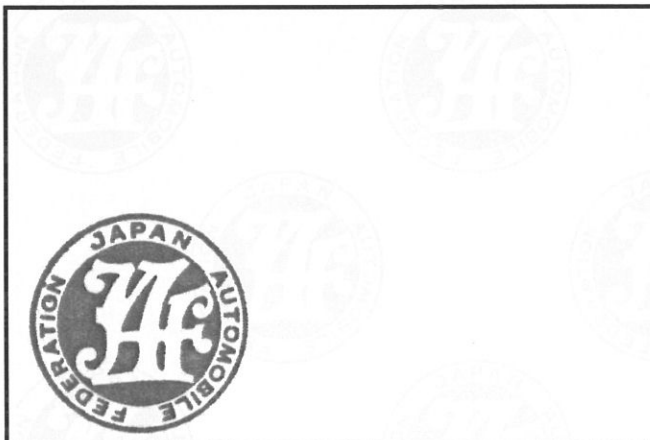
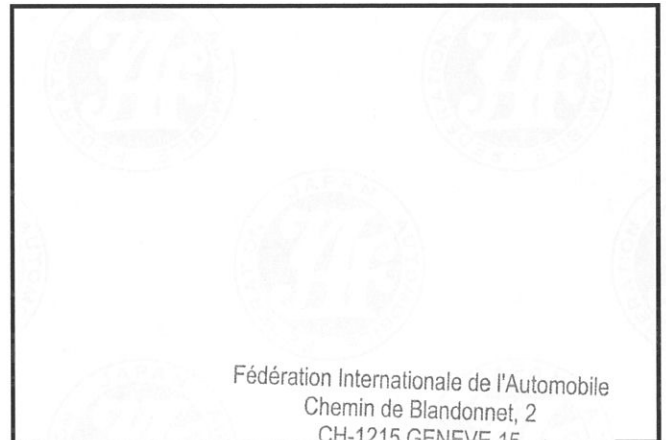

PHOTO N°



Fédération Internationale de l'Automobile
Chemin de Blandonnet, 2
CH-1215 GENEVE 15
Tél.: 41 22 544 44 00
Fax Sport: 41 22 544 44 50

Marque
Make
会社名 **FUJI**

Modèle
Model
型名 **GRB**

Homologation N°

N-5714

Extension N°

10/05 ER

JAF公認番号

FN-085 ER-11/5

PHOTO N° 0805313_1

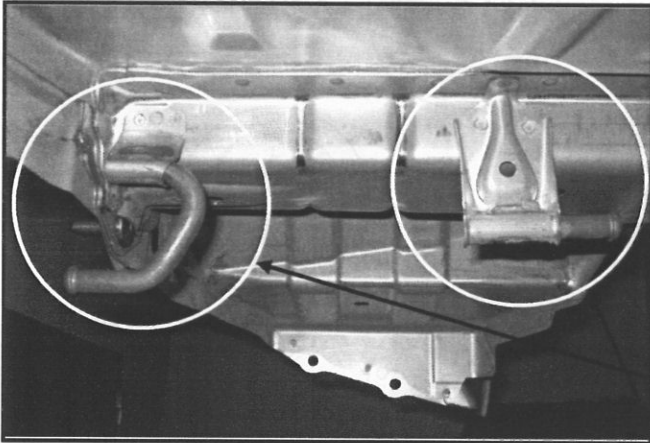

PHOTO N° 0805313_2

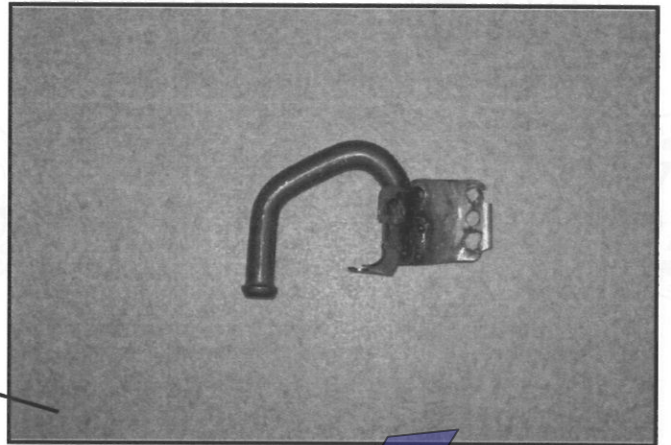

PHOTO N°

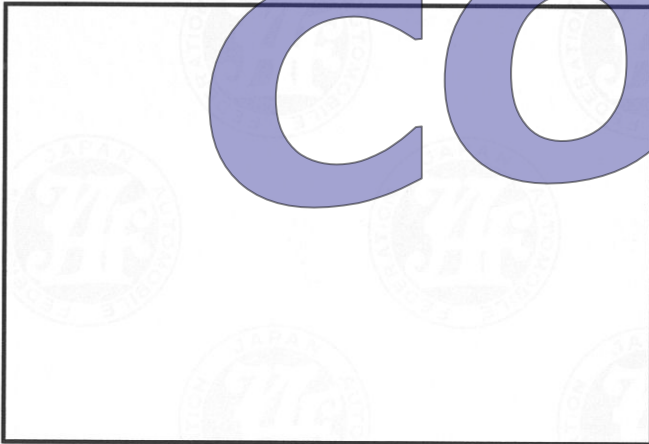

PHOTO N° 0805313_3

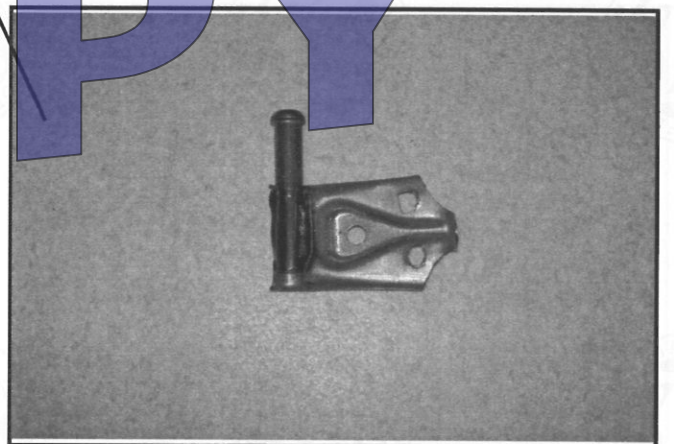

PHOTO N°

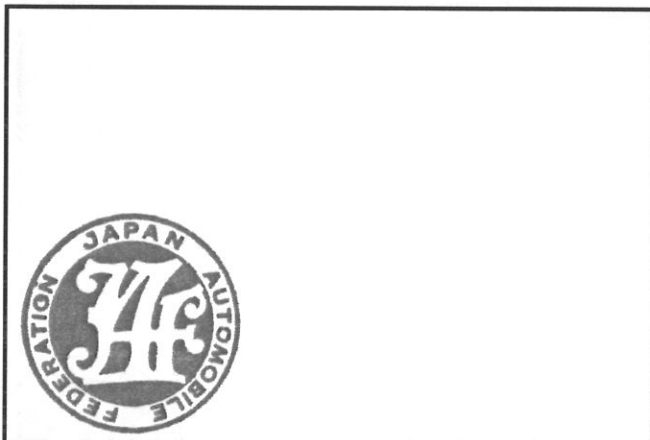
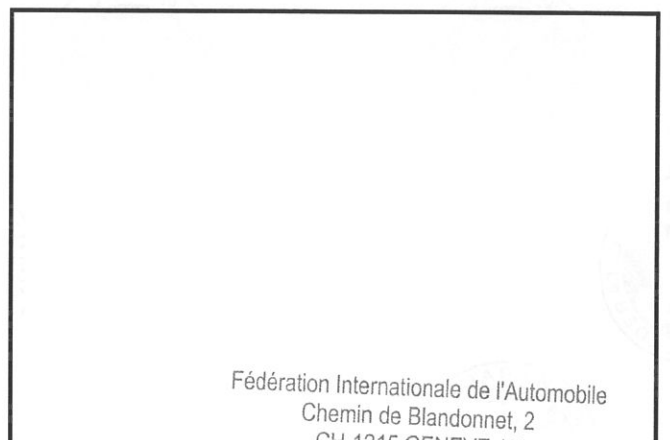

PHOTO N°



Marque
Make
会社名 **FUJI**

Modèle
Model
行名 **GRB**

Homologation N°

N-5714

Extension N°

10/05 ER

JAF公認番号

FN-085 ER-11/5

PHOTO N° 0805314_1

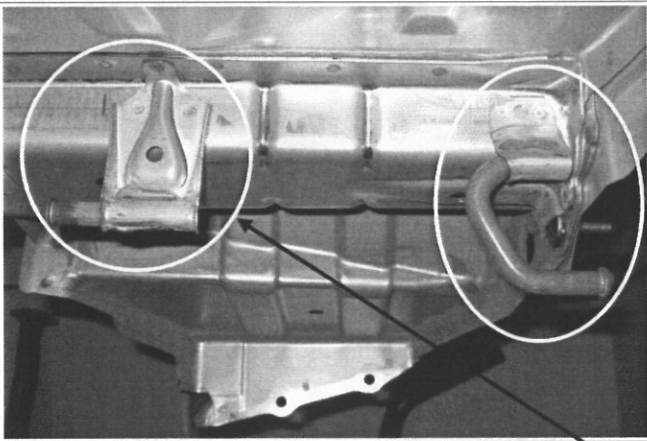

PHOTO N° 0805314_2



PHOTO N°

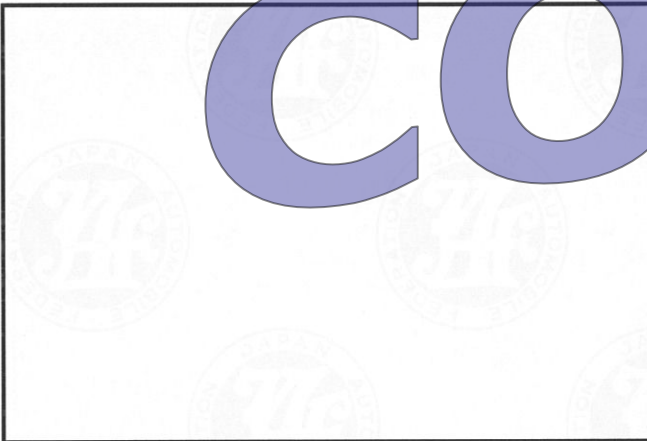

PHOTO N° 0805314_3

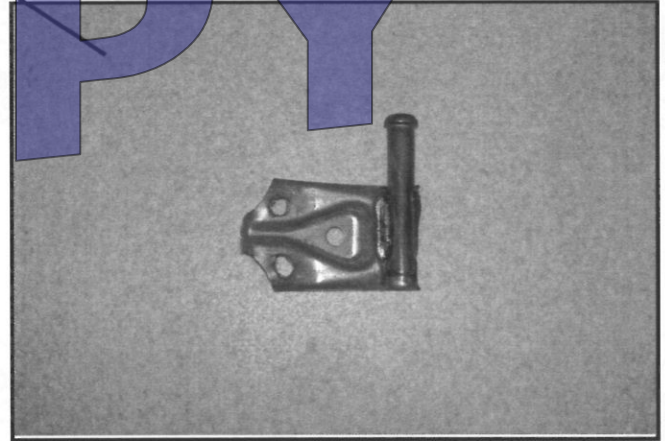
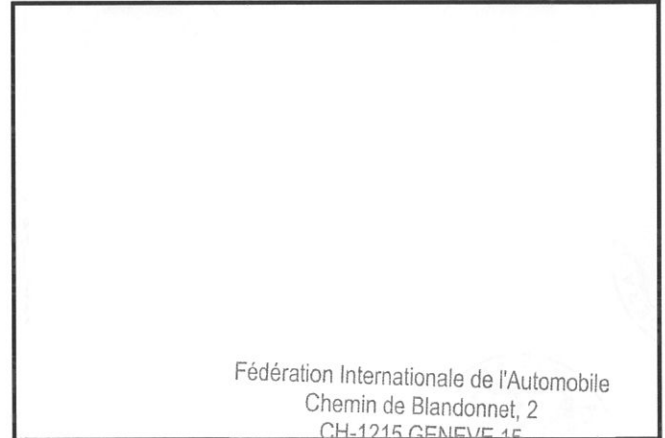

PHOTO N°



PHOTO N°



Fédération Internationale de l'Automobile
Chemin de Blandonnet, 2
CH-1215 GENEVE 15
Tél.: 41 22 544 44 00
Fax Sport: 41 22 544 44 50

Marque
Make
会社名 **FUJI**

Modèle
Model
行名 **GRB**

Homologation N°

N-5714

Extension N°

10/05 ER

JAF公認番号

FN-085 ER-11/5

PHOTO N° 0902311_1

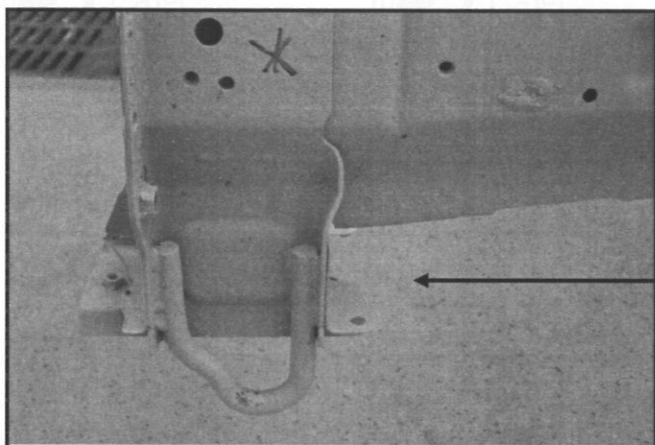

PHOTO N° 0902311_3

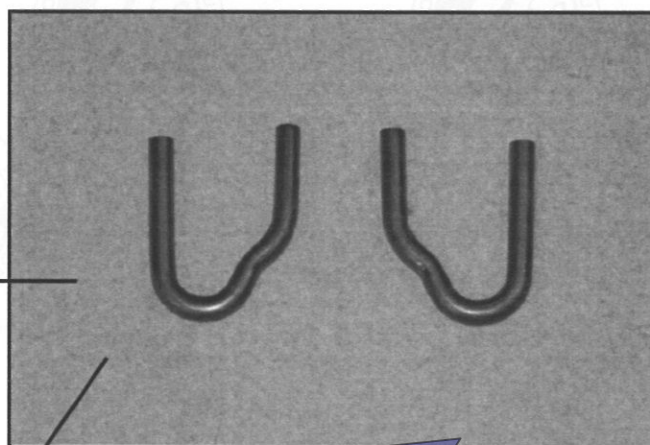

PHOTO N° 0902311_2

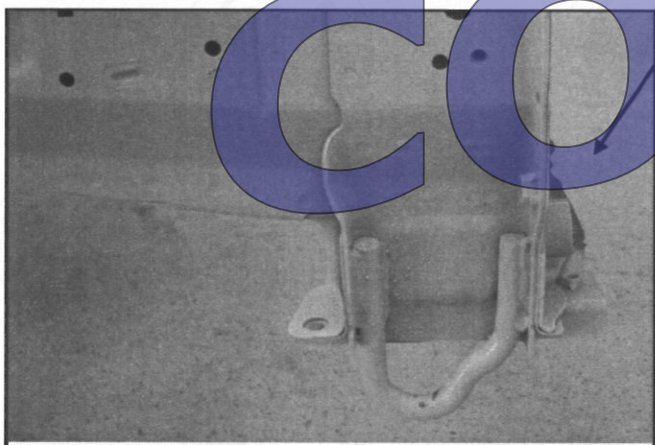
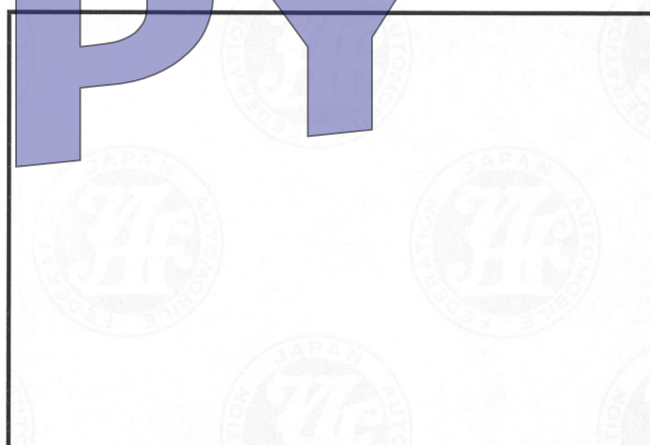

PHOTO N°



COPY

PHOTO N° 0902312_1



PHOTO N° 0902312_2

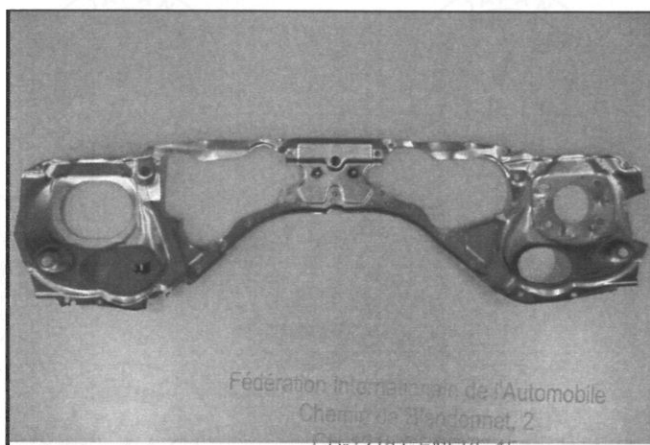

Fédération Internationale de l'Automobile
Chemin de St-Jacques, 2
CH-1015 SION, SUISSE

Tél.: 41 22 544 44 00
Fax Sport: 41 22 544 44 50

Marque
Make
会社名 **FUJI**

Modèle
Model
行名 **GRB**

Homologation N°

N-5714

Extension N°

10/05 ER

JAF公認番号

FN-085 ER-11/5

PHOTO N° 0902313_1

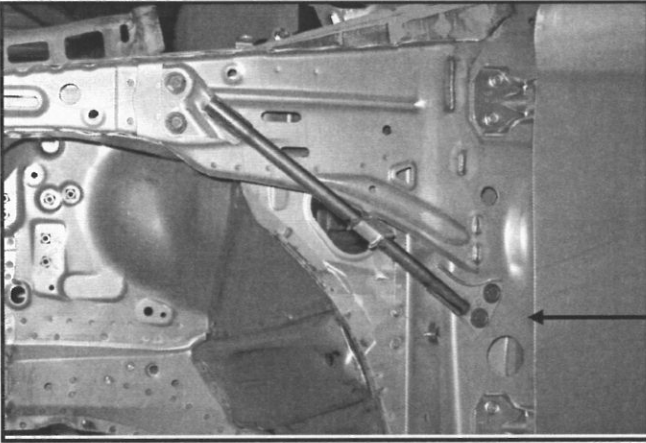

PHOTO N° 0902313_3

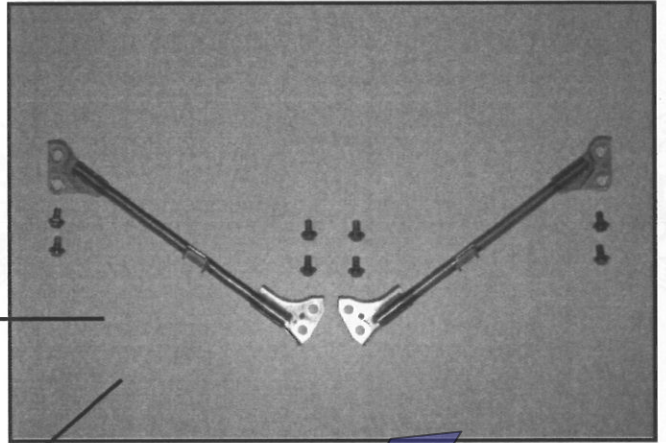

PHOTO N° 0902313_2

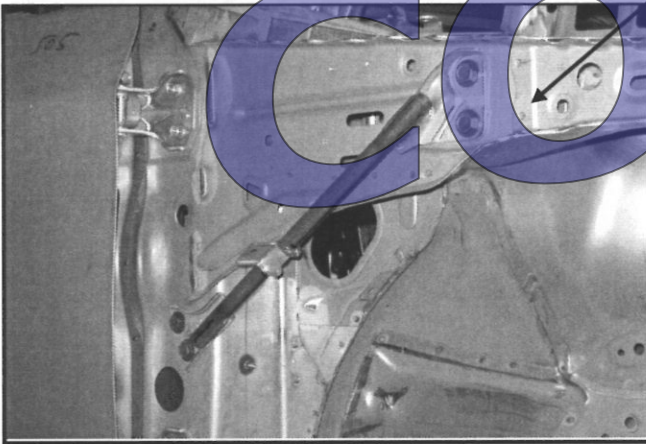

PHOTO N°

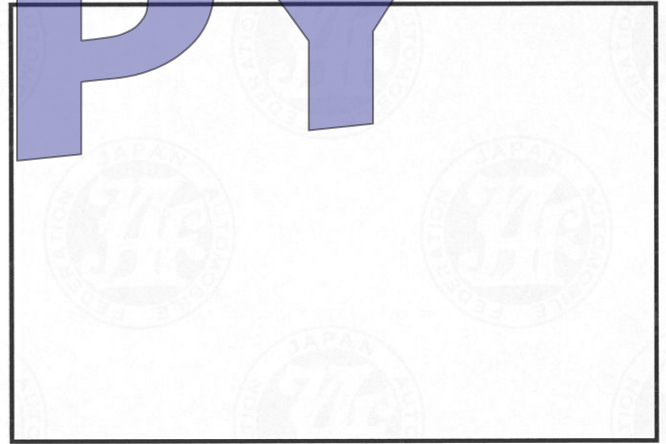

PHOTO N° 0902314_1

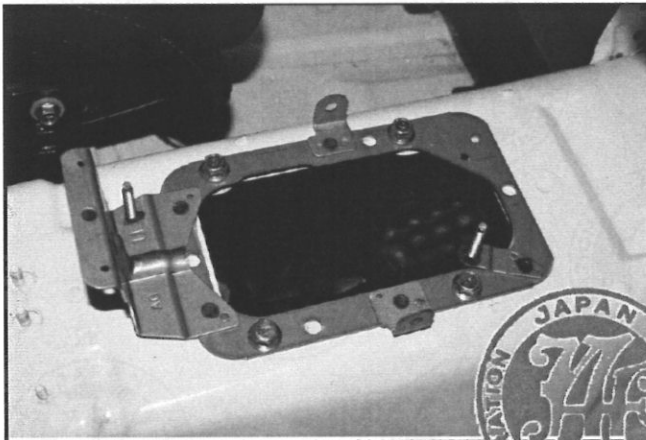
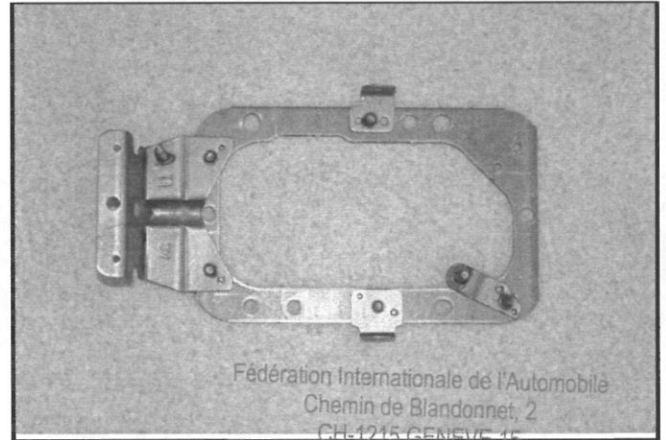

PHOTO N° 0902314_2



Fédération Internationale de l'Automobile
Chemin de Blandonnet, 2
CH-1215 GENEVE 15
Tél.: 41 22 544 44 00
Fax Sport: 41 22 544 44 50

Marque
Make
会社名 **FUJI**

Modèle
Model
車名 **GRB**

Homologation N°

N-5714

Extension N°

10/05 ER

JAF公認番号

FN-085 ER-11/5

PHOTO N° 0902315_1

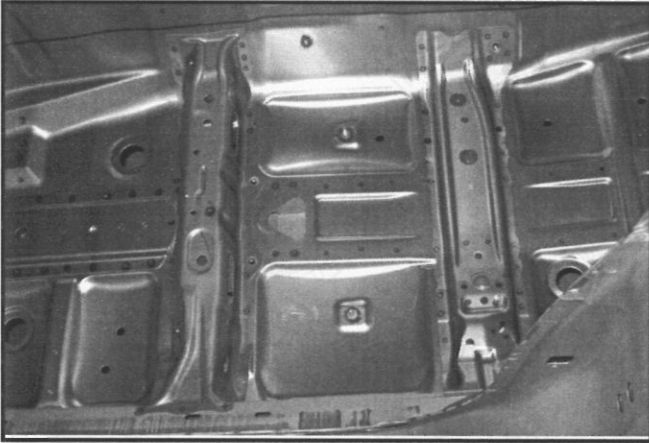

PHOTO N° 0902315_2

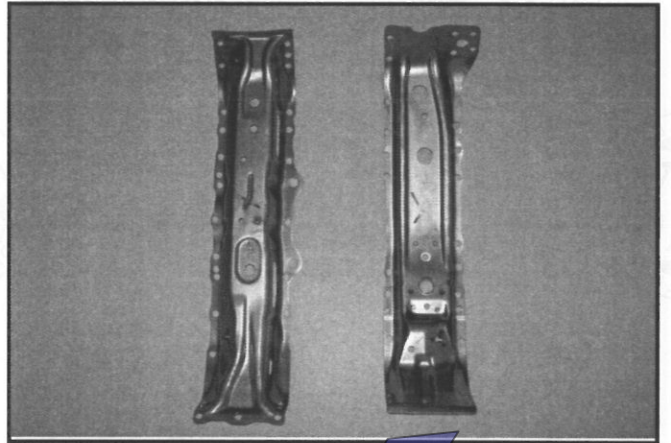

PHOTO N° 0902316_1

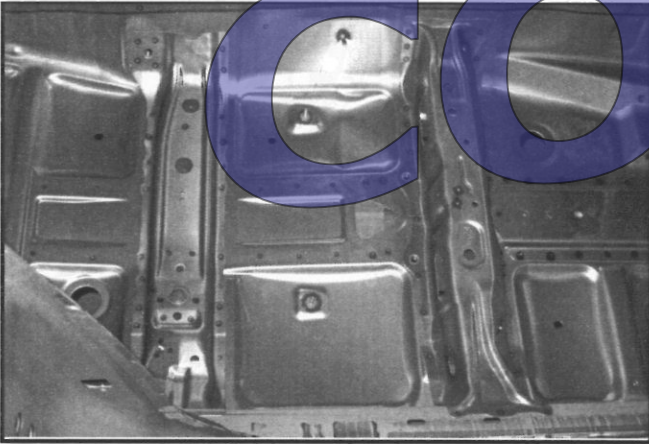

PHOTO N° 0902316_2

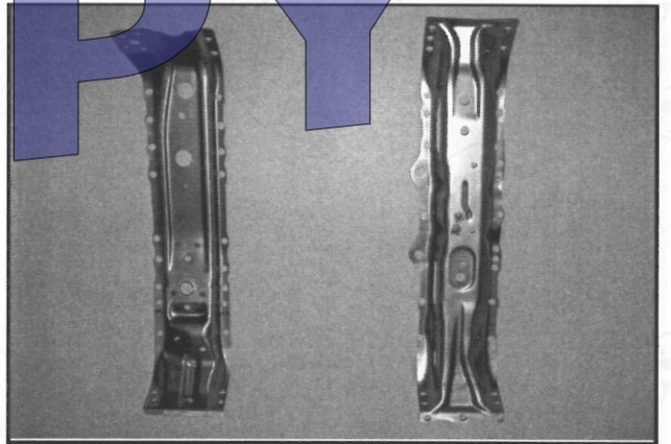
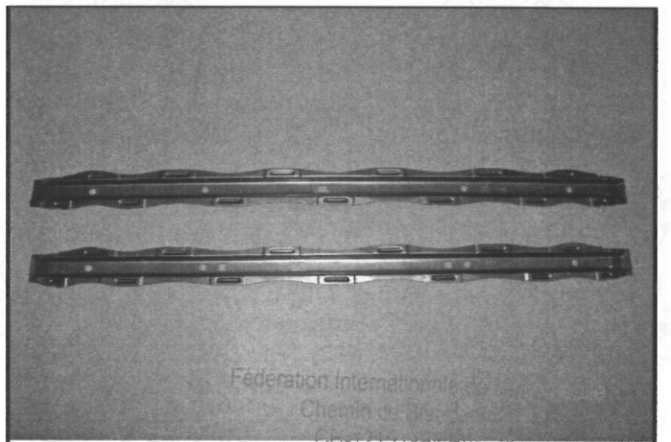

PHOTO N° 0902317_1



PHOTO N° 0902317_2



Fédération Internationale
Chemin de la
DIPLOME 18

Tél.: 41 22 544 44 00
Fax Sport: 41 22 544 44 50

Marque
Make
会社名 **FUJI**

Modèle
Model
行名 **GRB**

Homologation N°

N-5714

Extension N°

10/05 ER

JAF公認番号

FN-085 ER-11/5

PHOTO N° 0902318_1

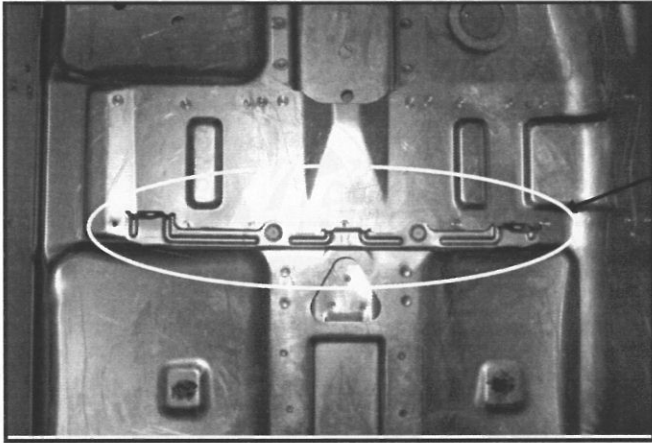

PHOTO N° 0902318_3

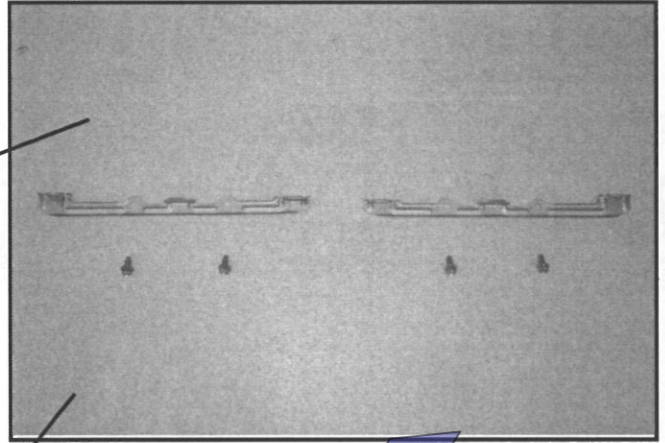

PHOTO N° 0902318_2

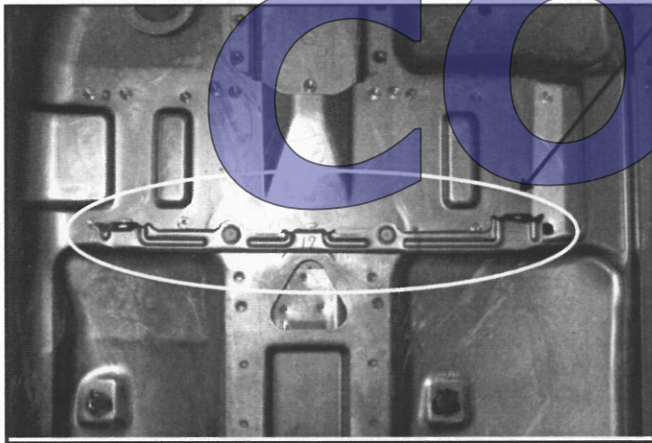

PHOTO N°

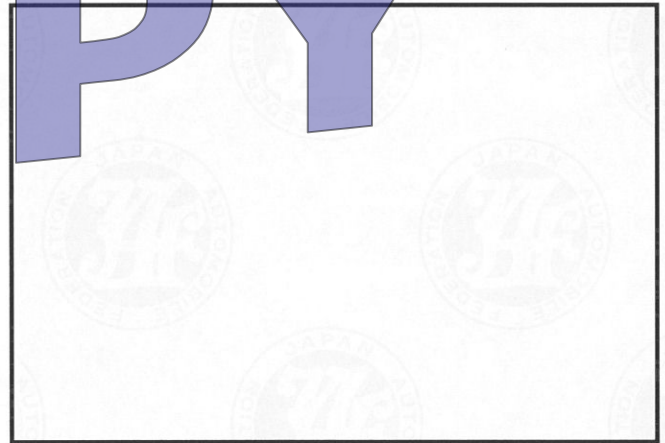

PHOTO N° 0902319_1

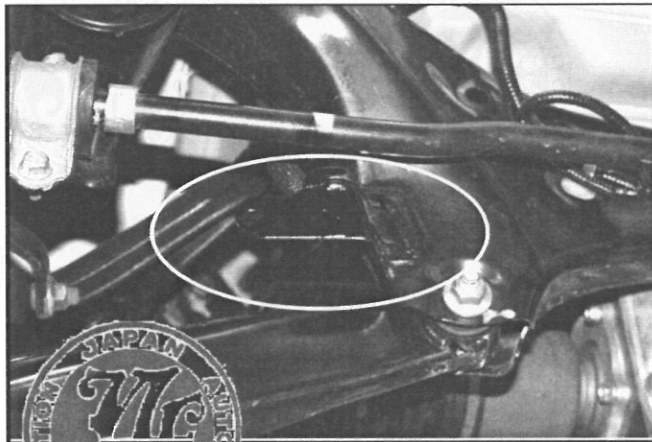
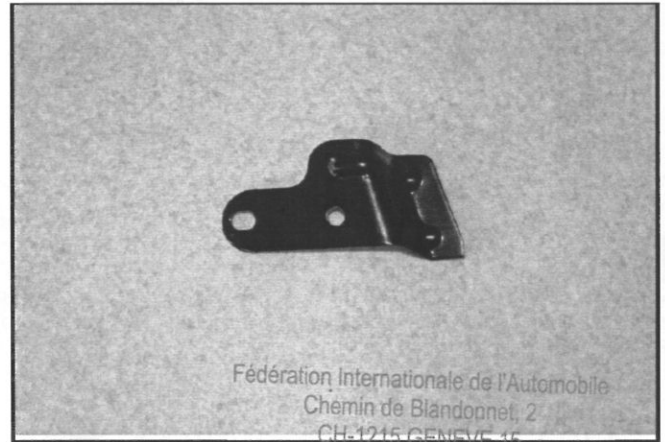

PHOTO N° 0902319_2



Fédération Internationale de l'Automobile
Chemin de Blandonnet, 2
CH-1215 GENEVE 15
Tél.: 41 22 544 44 00
Fax Sport: 41 22 544 44 50

Marque
Make
会社名 **FUJI**

Modèle
Model
型名 **GRB**

Homologation N°

N-5714

Extension N°

10/05 ER

JAF公認番号

FN-085 ER-11/5

PHOTO N° 0902320_1

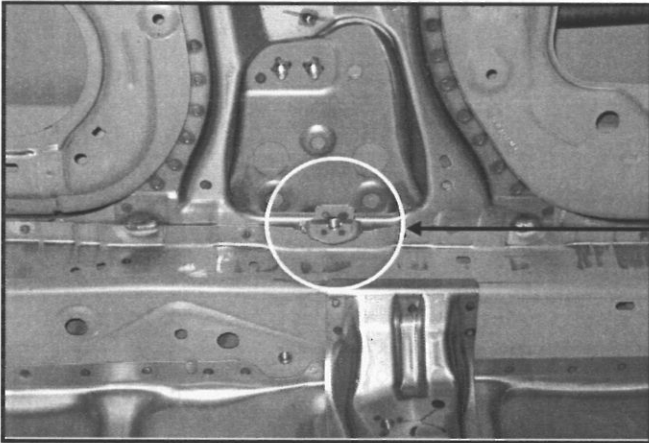

PHOTO N° 0902320_3

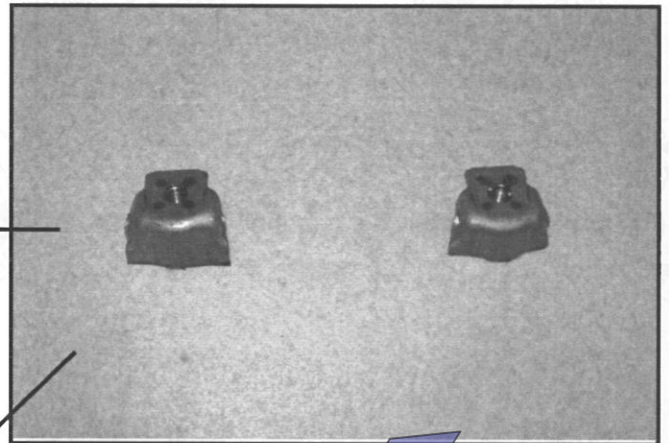

PHOTO N° 0902320_2

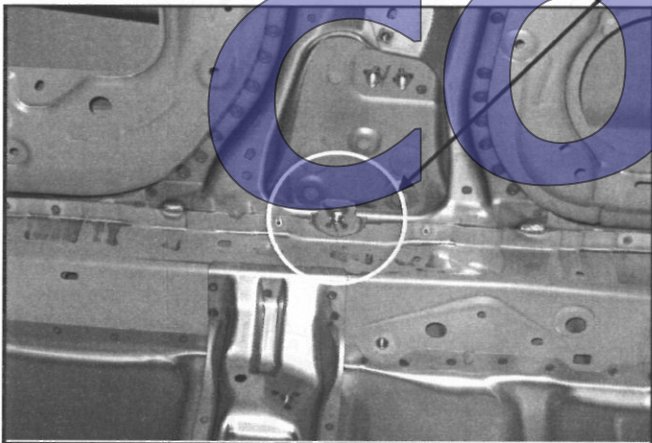

PHOTO N°



PHOTO N° 0902321_1

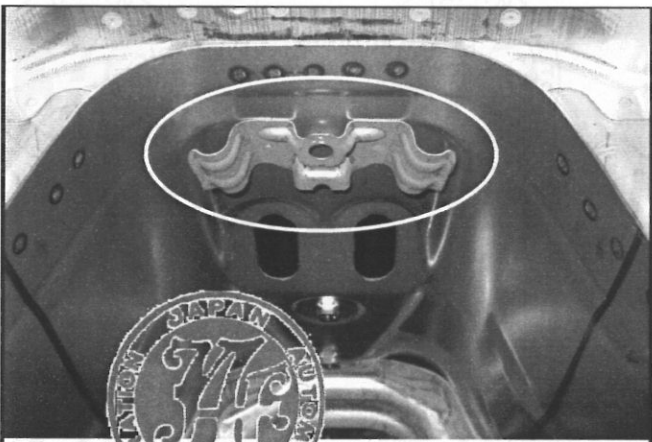
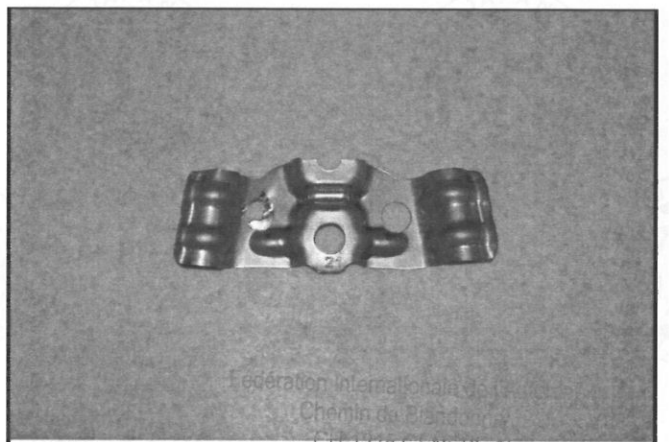

PHOTO N° 0902321_2



Fédération Internationale de Motocyclisme
Chemin du Pigeonnier
CHATELAINVILLE 16
Tél.: 41 22 544 44 00
Fax Sport: 41 22 544 44 50

Marque
Make
会社名 **FUJI**

Modèle
Model
行名 **GRB**

Homologation N°

N-5714

Extension N°

10/05 ER

JAF公認番号

FN-085 ER-11/5

PHOTO N° 0902322_1



PHOTO N° 0902322_3

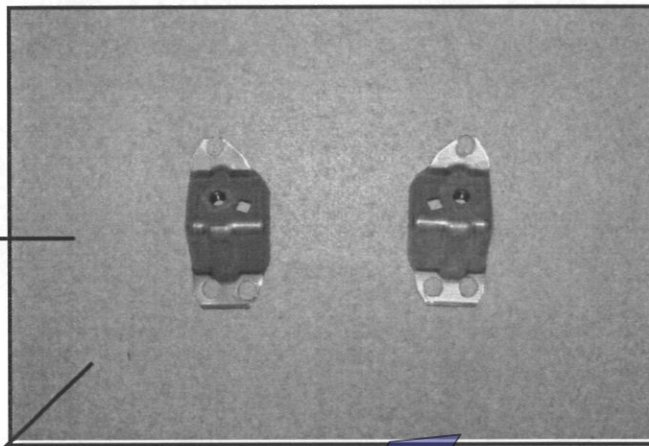

PHOTO N° 0902322_2

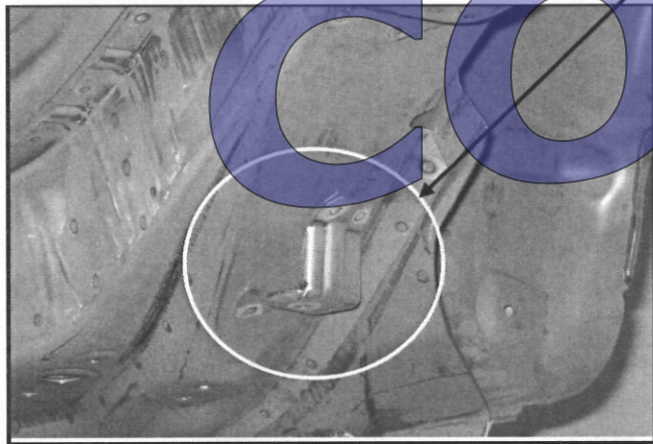

PHOTO N°

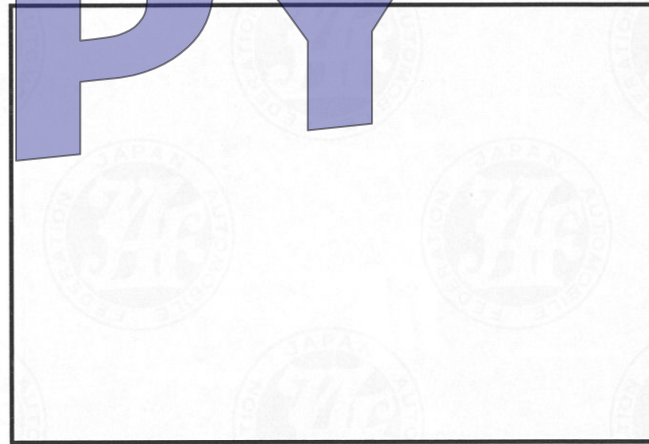

PHOTO N° 0902323_1

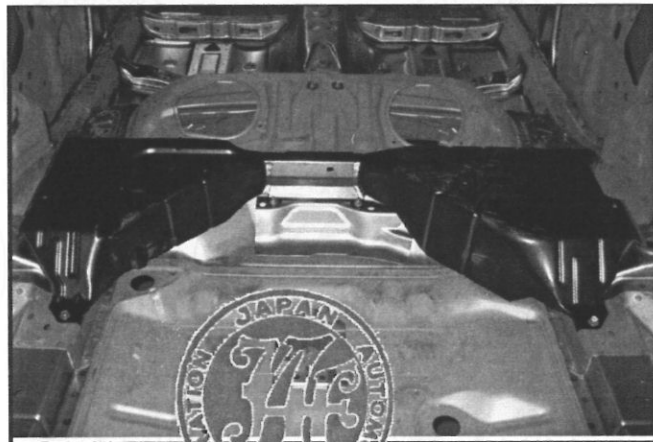
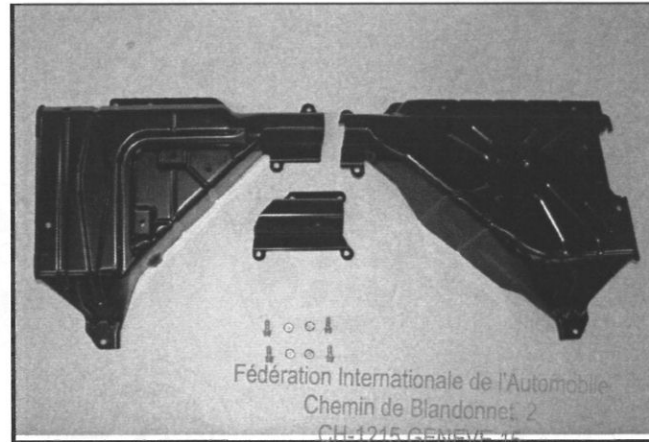

PHOTO N° 0902323_2



Fédération Internationale de l'Automobile
Chemin de Blandonnet, 2
CH-1215 GENEVE 15
Tél.: 41 22 544 44 00
Fax Sport: 41 22 544 44 50

Marque
Make
会社名 **FUJI**

Modèle
Model
行名 **GRB**

Homologation N°

N-5714

Extension N°

10/05 ER

JAF公認番号

FN-085 ER-11/5

PHOTO N° 0902324_1

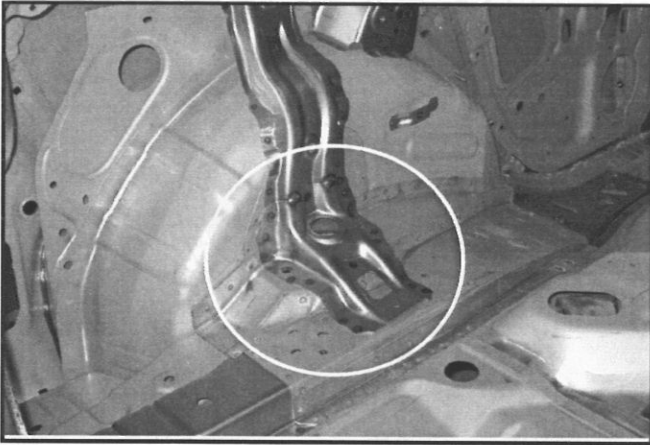

PHOTO N° 0902324_2

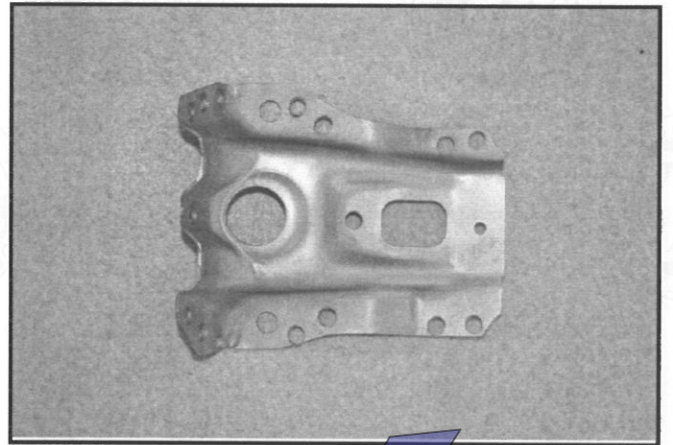

PHOTO N° 0902325_1

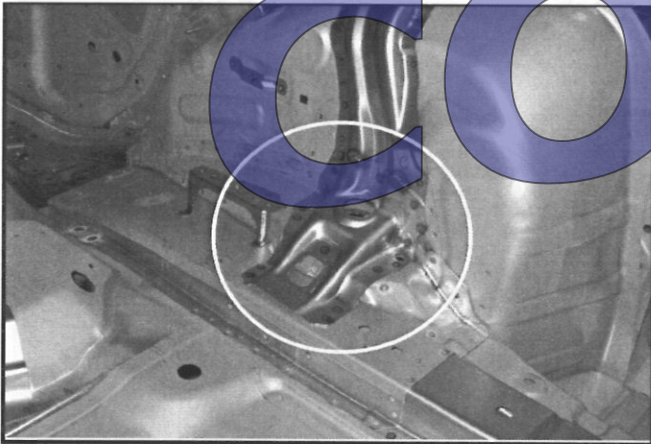

PHOTO N° 0902325_2

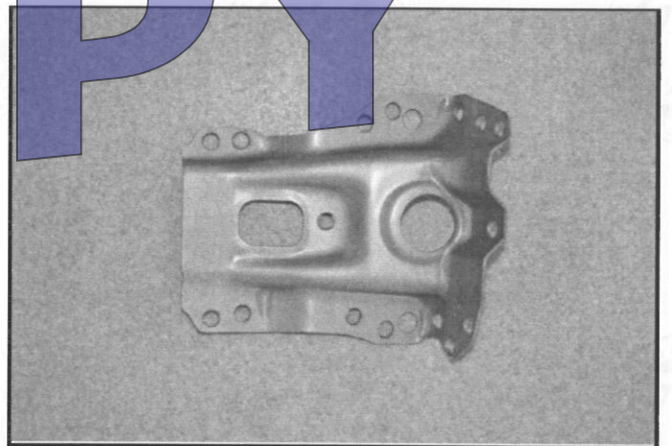

PHOTO N° 0902326_1

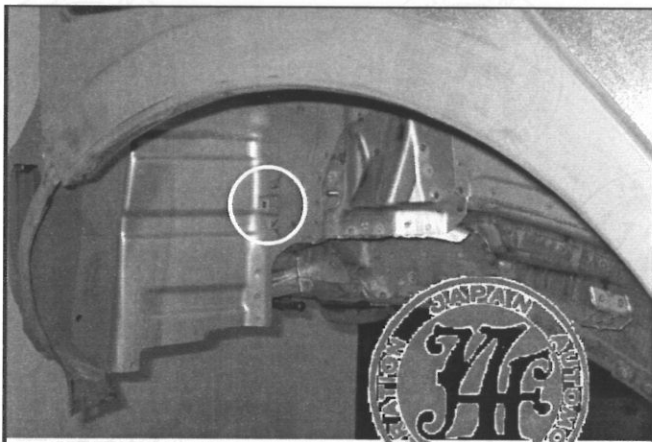
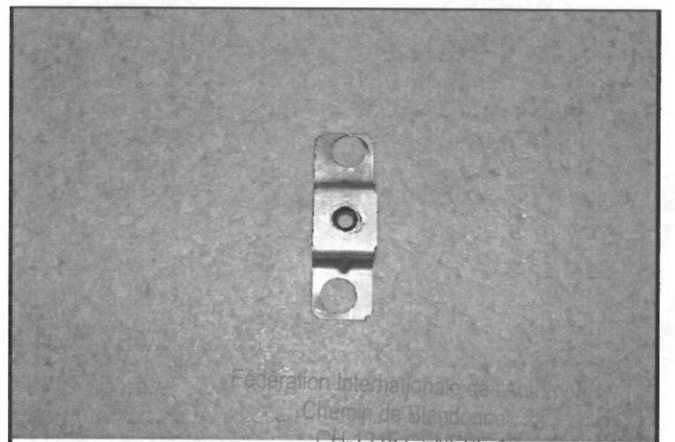

PHOTO N° 0902326_2



Fédération Internationale de l'Automobile
Chemin de Blandouard
CHATELAIN GEMMEVE 46

Tél.: 41 22 544 44 00
Fax Sport: 41 22 544 44 50

Marque
Make
会社名 **FUJI**

Modèle
Model
行名 **GRB**

Homologation N°

N-5714

Extension N°

10/05 ER

JAF公認番号

FN-085 ER-11/5

PHOTO N° 0902327_1



PHOTO N° 0902327_2

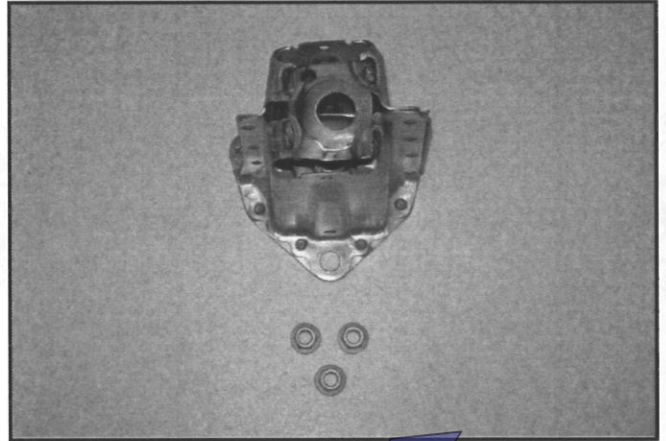

PHOTO N° 0902328_1

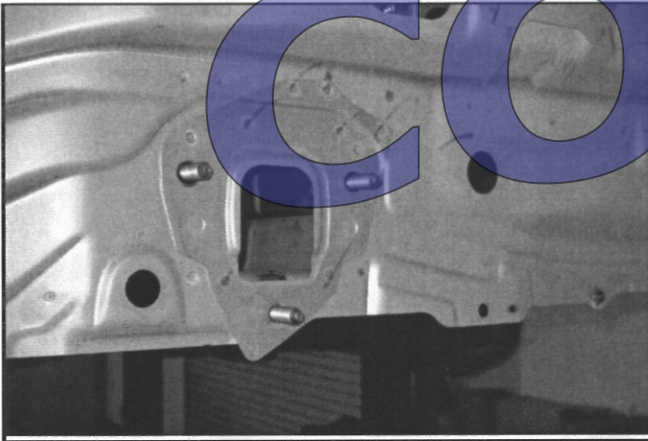

PHOTO N° 0902328_2

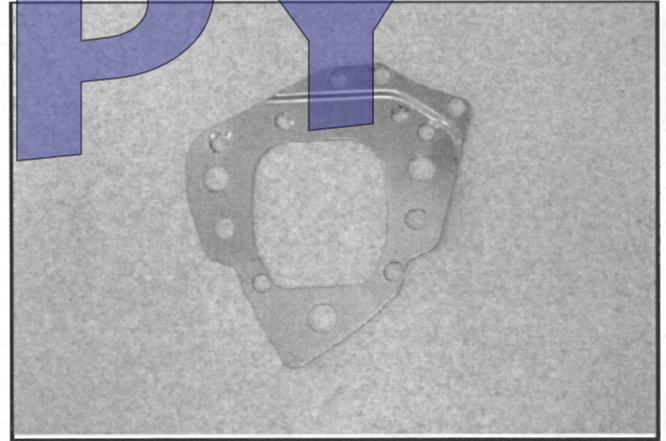

PHOTO N° 0902329_1

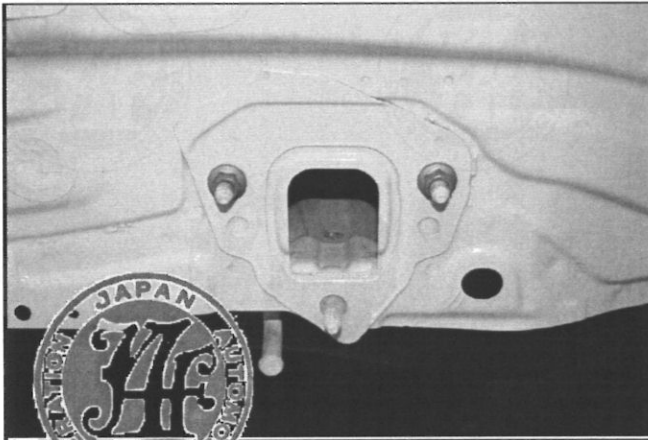

PHOTO N° 0902329_2



Fédération Internationale de l'Automobile
Chemin de Blandonnet, 2
CH-1215 GENEVE 15
Tél.: 41 22 544 44 00
Fax Sport: 41 22 544 44 50

Marque
Make
会社名 **FUJI**

Modèle
Model
行名 **GRB**

Homologation N°

N-5714

Extension N°

10/05 ER

JAF公認番号

FN-085 ER-11/5

PHOTO N° 0902330_1

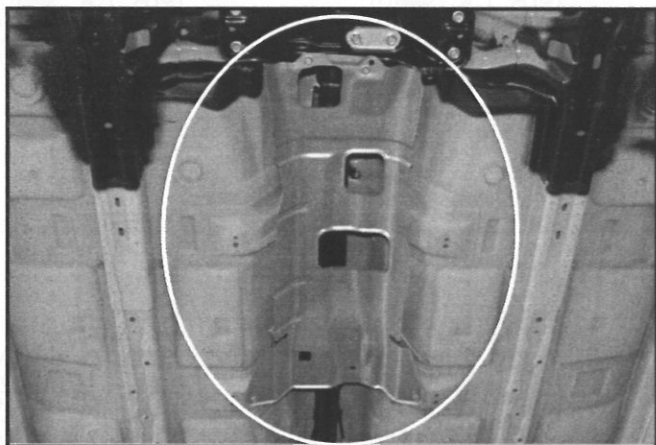

PHOTO N° 0902330_2

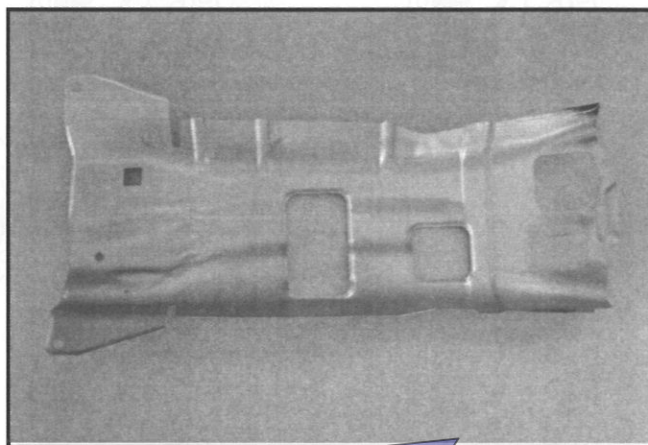

PHOTO N° 0902331_1

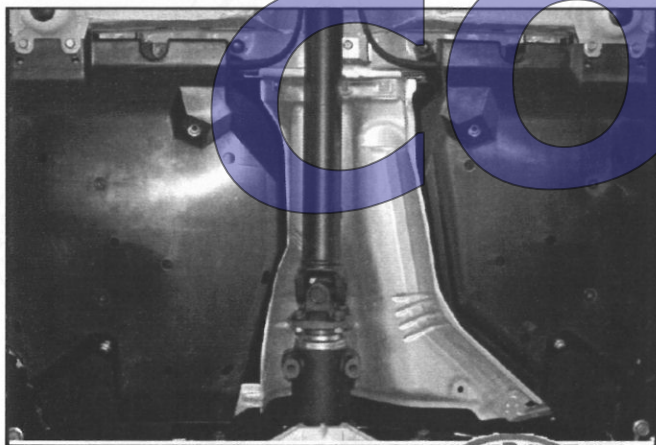

PHOTO N° 0902331_2

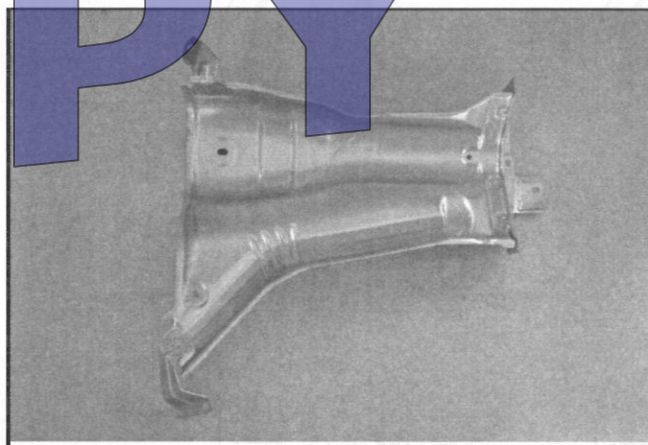

PHOTO N° 0902332_1

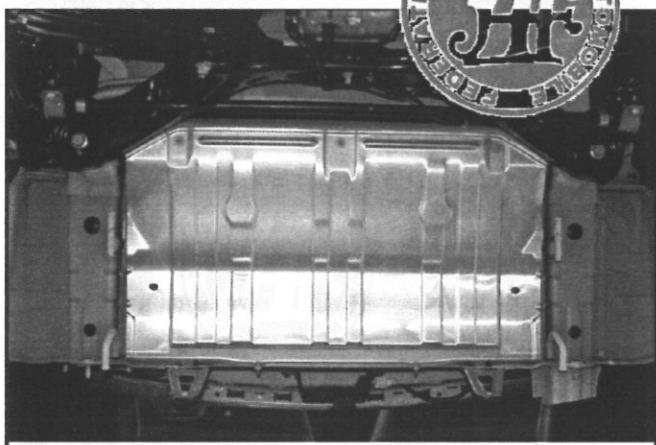
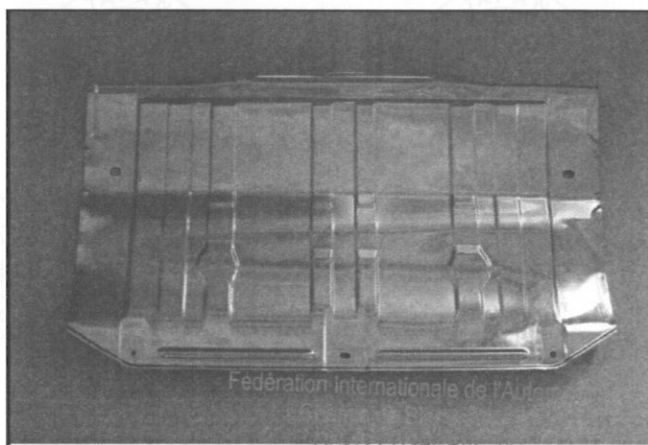

PHOTO N° 0902332_2



Fédération internationale de l'Automobile
Tél.: 41 22 544 44 00
Fax Sport: 41 22 544 44 50