



FEDERATION INTERNATIONALE  
DE L'AUTOMOBILE

JAPAN AUTOMOBILE FEDERATION  
社団法人 日本自動車連盟

Gruppe / Group / グループ

**N**

Homologation N°

**N-5714**

Extension N°

**09/05 VO**

**NON VALABLE EN SUPER PRODUCTION**  
**NOT VALID IN SUPER PRODUCTION**

JAF公認番号 **FN-085 VO-10/5**

JAF発効日 **2009年3月1日**

FICHE D'EXTENSION D'HOMOLOGATION  
HOMOLOGATION EXTENSION FORM

追加公認書式

- |                                    |   |   |  |
|------------------------------------|---|---|--|
| <input type="checkbox"/> <b>ES</b> | Evolution sportive du type / Sporting evolution of the type<br>スポーツ進化 | <input checked="" type="checkbox"/> <b>VO</b> | Variante option / Option variant<br>オプション変型              |
| <input type="checkbox"/> <b>ET</b> | Evolution normale du type / Normal evolution of the type<br>型式の正常進化   | <input type="checkbox"/> <b>VP</b>            | Variante de Production / Production variant<br>生産オプション変型 |
| <input type="checkbox"/> <b>VF</b> | Variante de fourniture / Supply variant<br>供給変型                       | <input type="checkbox"/> <b>ER</b>            | Erratum / Erratum<br>誤記訂正                                |

Véhicule : Constructeur

Vehicle : Manufacturer

車両 : 製造会社名

**FUJI HEAVY INDUSTRIES LTD.**

Modèle et type

Model and type

モデルと型式

**SUBARU IMPREZA WRX STI (2007), GRB**

Homologation valable à partir du

Homologation valid as from

FIA公認発効年月日

**01 MARS 2009**

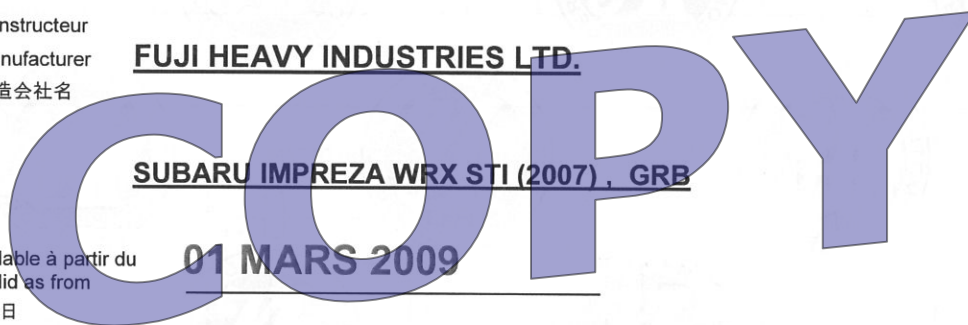

| Page or ext.<br>頁または追加番号 | Article<br>項目 | Description<br>記述   |
|--------------------------|---------------|---|
|                          | 3<br>334      | <p><b>ENGINE<br/>TURBO CHARGING</b><br/><u>Original model :</u><br/><u>Homologation No.A/N-5695 01/01VP with Homologation No.A/N-5695 13/02VF</u></p> <p><b>INTERCOOLER WATER SPRAY SYSTEM</b></p> <p>Photo 0902301) Intercooler spray kit<br/>Drawing 0902901) Intercooler spray system<br/>Water tank location : between the crew and the rear suspension top mount<br/>System is not connected to the ECU</p> <p>Photo 0902302) Water tank mounting example - behind the seat, LH - Brackets may vary<br/>Photo 0902303) Water tank mounting example - behind the seat, RH - Brackets may vary<br/>Photo 0902304) Water tank mounting example - beside rear door, LH - Brackets may vary<br/>Photo 0902305) Water tank mounting example - beside rear door, RH - Brackets may vary</p> <p><b>RESTRICTOR</b></p> <p>Photo 0902306) Restrictor &amp; duct assembly, type 3N<br/>Photo 0902307) Disassembled parts, type 3N<br/>Elbow turbo charger : Part number "C2/J2/009"<br/>Restrictor : Part number "N12/J2/001"</p> |



Federation Internationale de l'Automobile  
Chemin de Blandonnet, 2  
CH-1215 GENEVE 15  
Tél.: +41 22 544 44 00  
Fax Sport: +41 22 544 44 50

Marque  
Make  
会社名 FUJI

Modèle  
Model  
行名 GRB

Homologation N°

N-5714

Extension N°

09/05 VO

JAF公認番号

FN-085 VO-10/5

PHOTO N° 0902301

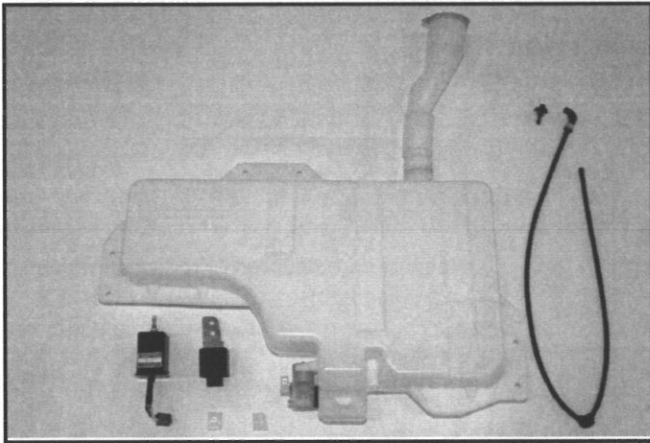

**The parts included in the kit**

- INT. TIMER UNIT
- TIMER UNIT
- CONNECTOR FOR THE TIMER UNIT
- WATER TANK (Tank Capacity 12.6± 1Litre)
- WATER PUMP
- CONNECTOR FOR THE WATER PUMP
- ONEWAY VALVE with HOSE
- SPLAY NOZZLE

DRAWING N° 0902901

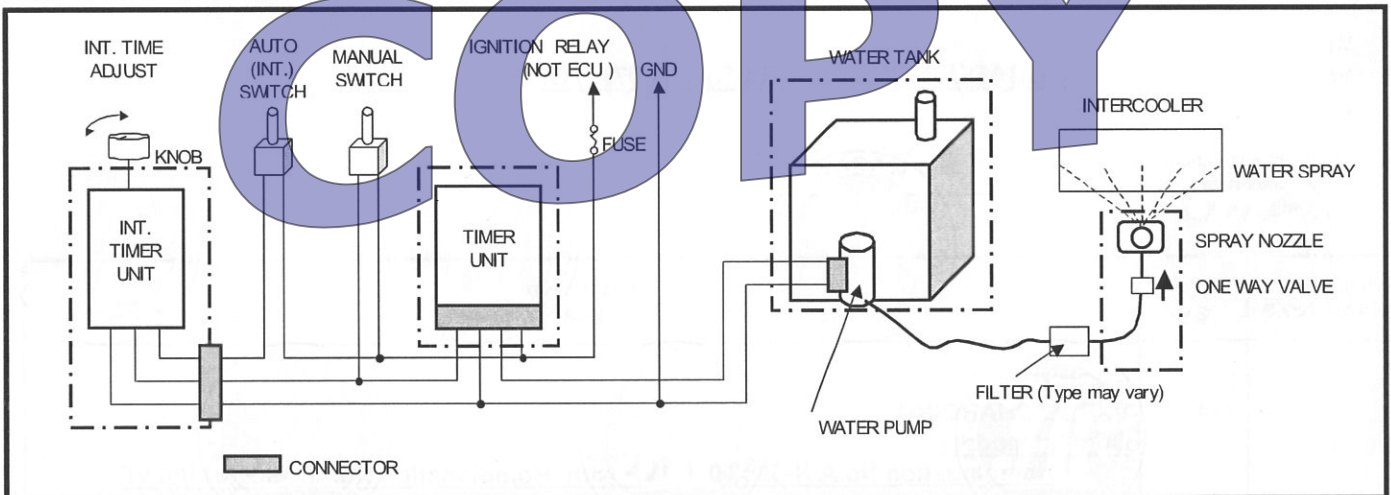

PHOTO N° 0902302

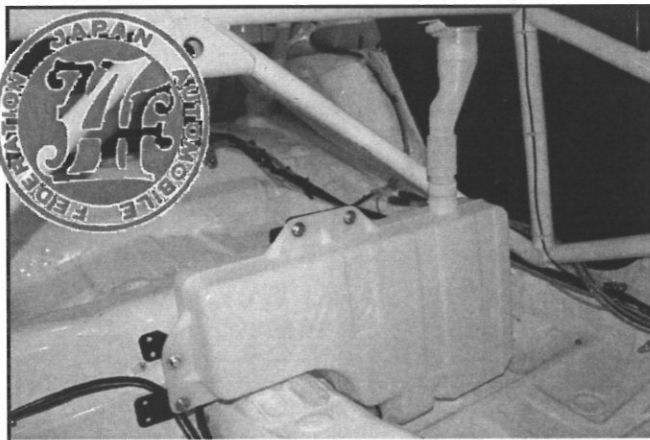
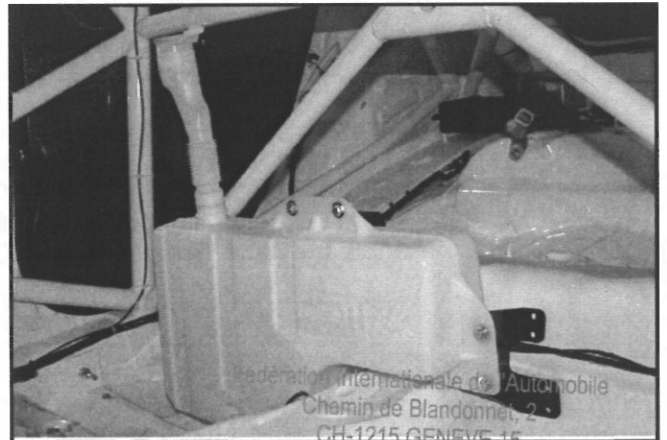

PHOTO N° 0902303



Fédération Internationale de l'Automobile  
Chemin de Blandonnet, 2  
CH-1215 GENEVE 16

Tél.: 41 22 544 44 00  
Fax Sport: 41 22 544 44 50

Marque  
Make  
会社名 FUJI

Modèle  
Model  
行名 GRB

Homologation N°

N-5714

Extension N°

09/05 VO

JAF公認番号

FN-085 VO-10/5

PHOTO N° 0902304

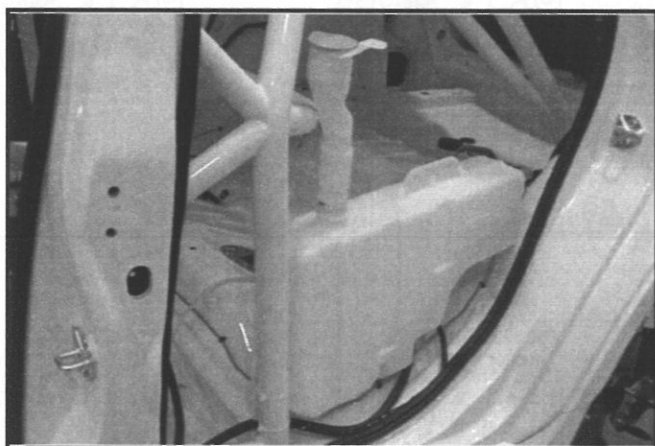

PHOTO N° 0902305



PHOTO N° 0902306

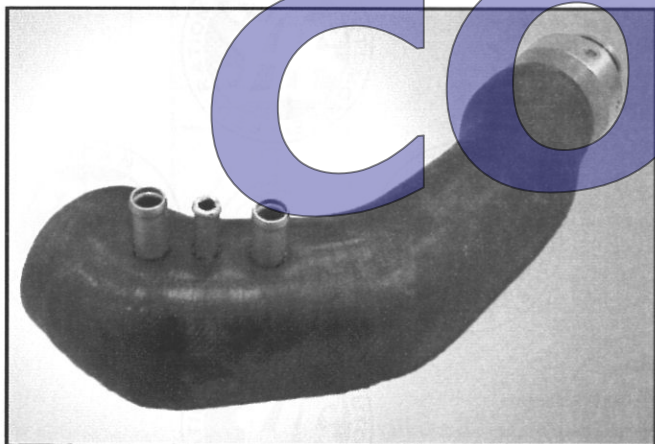

PHOTO N° 0902307

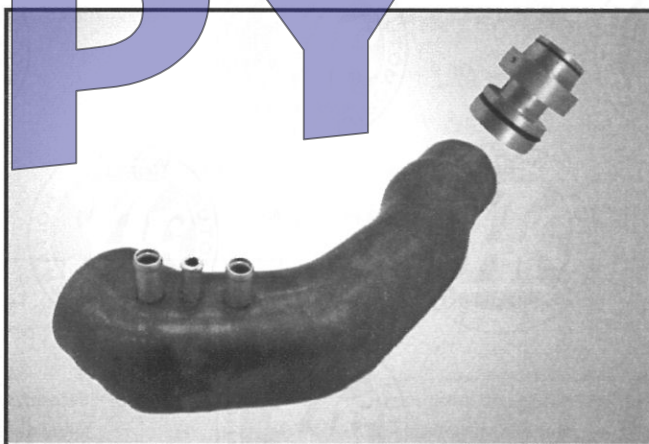

PHOTO N°

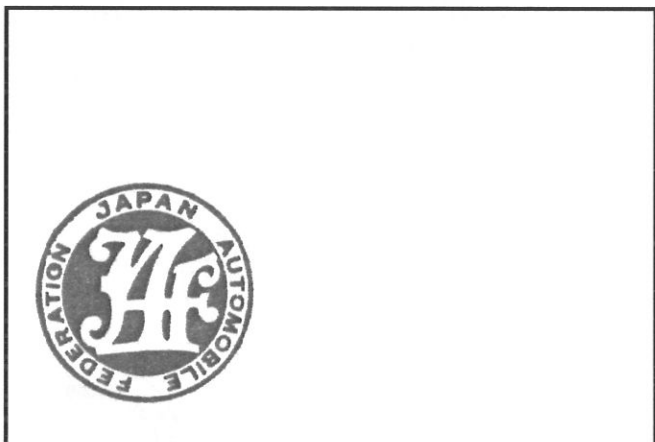

PHOTO N°



Marque  
Make  
会社名 FUJI

Modèle  
Model  
モデル GRB

Homologation N°

N-5714

Extension N°

09/05 VO

JAF公認番号

FN-085 VO-10/5

334. Suralimentation  
Turbocharging  
ターボチャージャー

b) Carter de turbine  
Turbine housing タービンハウジング

a) Marque et type du turbocompresseur  
Make and type of the turbocharger **IHI , RH**  
ターボチャージャーの製造会社名と型式

b1) Nombre d'entrées des gaz d'échappement  
Number of exhaust gas entries 排気取り入れ口の数 **2**

b2) Matériau  
Material 材質 **CAST-IRON**

c) Roue de turbine  
Turbine wheel タービンホイール

c1) Matériau  
Material 材質 **STEEL**

c2) Nombre d'aubes  
Number of blades **11**  
ブレードの数

c3) Hauteur(s) des aubes  
Height(s) of blades **22.8** +/- 0.5 mm  
ブレードの高さ

c4) Cotes A, B, C, selon le schéma suivant  
Dimensions A, B, C, according to the following sketch  
右図のA,B,Cの寸法

A = **49.1** +/- 0.4 mm

B = **9.4** +/- 0.5 mm

C = **53.0** +/- 0.3 mm (When it is new)

C = **53.4** +/- 0.3 mm (When it is after used)

c5) Aubes variables  
Variable blades 可変ブレード

oui  
yes 有

non  
no 無

d) Carter de compression  
Impeller housing インペラハウジング

d1) Nombre d'entrées d'air (mélange)  
Number of air entries (gas) 空気取り入れ口の数 **1**

d2) Matériau  
Material 材質 **ALUMINIUM ALLOY**

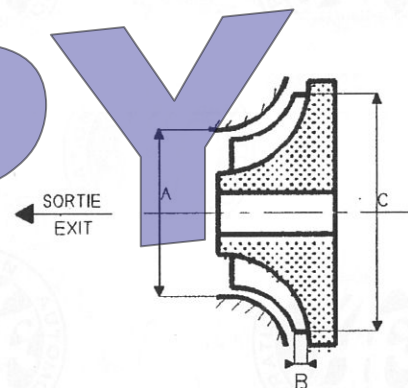

Fédération Internationale de l'Automobile  
Chemin de Blandonnet, 2  
CH-1215 GENEVE 15  
Tél.: 41 22 544 44 00  
Fax Sport: 41 22 544 44 50

Marque  
Make  
会社名 FUJI

Modèle  
Model  
モデル GRB

Homologation N°

N-5714

Extension N°

09/05 VO

JAF公認番号

FN-085 VO-10/5

e) Roue de compression  
Impeller wheel インパeller

e1) Matériau  
Material 材質 **ALUMINIUM ALLOY**

e2) Nombre d'aubes  
Number of blades **12**  
ブレードの数

e3) Hauteur(s) des aubes  
Height(s) of blades **6 blades of 24.1 +/- 0.5 mm  
and 6 blades of 14.1 +/- 0.5 mm**  
ブレードの高さ

e4) Cotes A, B, C, selon le schéma suivant  
Dimensions A, B, C, according to the following sketch  
右図のA,B,Cの寸法

A = **47.1** +/- 0.4 mm  
B = **5.6** +/- 0.5 mm  
C = **60.0** +/- 0.4 mm

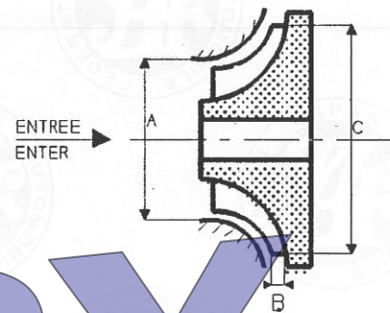

e5) Aubes variables  
Variable blades 可変ブレード

|                                       |   |
|---------------------------------------|---|
| <input type="checkbox"/> oui<br>yes 有 | <input checked="" type="checkbox"/> non<br>no 無 |
|---------------------------------------|---|

f) Régulation de la pression  
Pressure regulation 圧力調整

f1) Type de régulation de la pression :  
Type of pressure adjustment :  
圧力調整の方式

|  |  |   |
|--|--|---|
| <input type="checkbox"/> by-pass<br>バイパス | <input checked="" type="checkbox"/> soupape de décharge<br>relief valve<br>リリーフバルブ | <input type="checkbox"/> autre cas<br>other case<br>その他 |
|--|--|---|

f2) Type de la soupape  
Type of the valve **DIAPHRAGM**  
バルブの形式

g) Système d'échappement  
Exhaust system 排気方式

g1) Dimensions intérieures de(s) éventuel(s) tuyau(x) d'échappement entre collecteur d'échappement et turbocompresseur / Internal dimensions of the possible exhaust pipe(s) between exhaust manifold and turbocharger **xxx** mm

エキゾーストマニホールドとターボの間エキゾーストパイプの内径

h) Refroidissement de l'air d'admission  
Cooling of the intake air 吸気冷却

h1)  oui  
yes 有  non  
no 無

h2) Système  
System 方式  air/air  
air/air 空気/空気  air/eau  
air/water 空気/水  simple-passe  
single-flow 単流  double-passe  
double-flow 複流

Capacité en eau  
Water capacity 水の容量 **xxx** l

h3) Diamètre de l'entrée d'air  
Air inlet diameter **60** +/-1 mm X2  
吸気口径

h4) Diamètre de la sortie d'air  
Air outlet diameter **65** +/-1 mm  
排気口径



Fédération Internationale de l'Automobile  
Chemin de Blandonnet, 2  
CH-1215 GENEVE 15  
Tél.: 41 22 544 44 00  
Fax Sport: 41 22 544 44 50

Marque  
Make  
会社名 FUJI

Modèle  
Model  
行名 GRB

Homologation N°

N-5714

Extension N°

09/05 VO

JAF公認番号

FN-085 VO-10/5

PHOTOS / PHOTOS / 写真

K) Vue de dessus du turbocompresseur  
Plan view of turbocharger ターボチャージャーの上面視

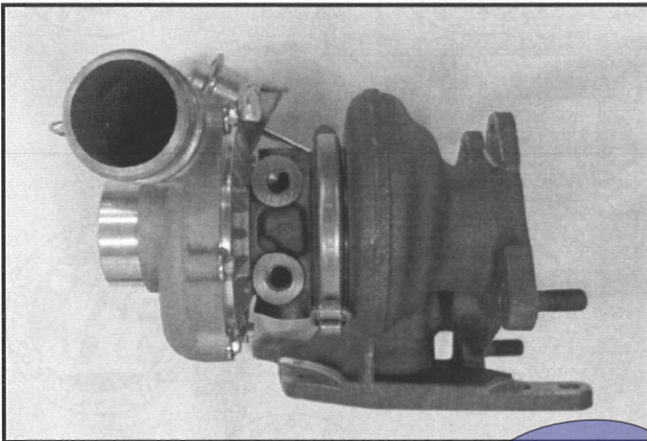

L) Vue de face du turbocompresseur  
Front view of turbocharger ターボチャージャーの前面視

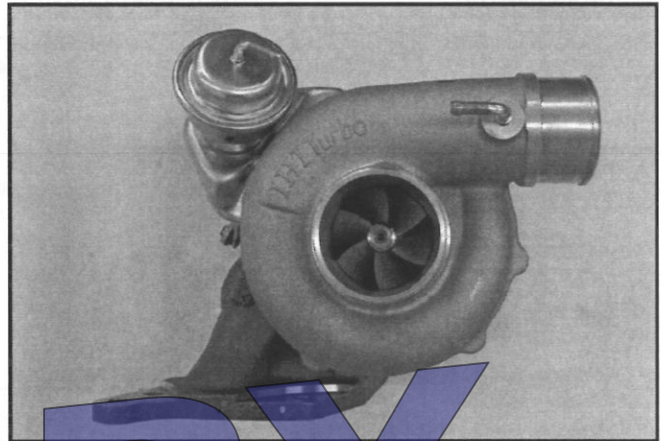

M) Vue de côté du turbocompresseur  
Side view of turbocharger ターボチャージャーの側面視

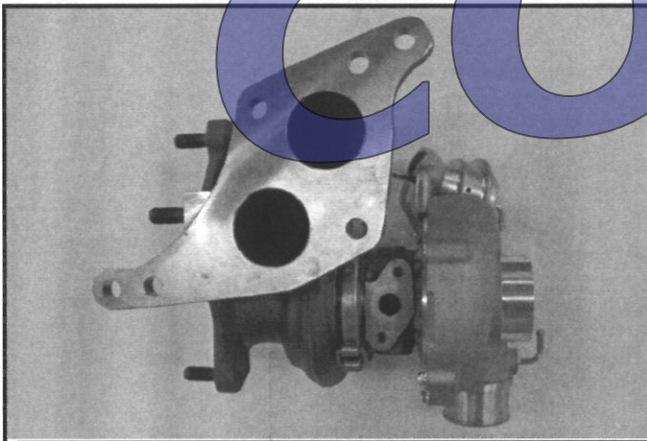

N) Carter de turbine du turbocompresseur  
Turbine housing of turbocharger ターボチャージャーのタービンハウジング

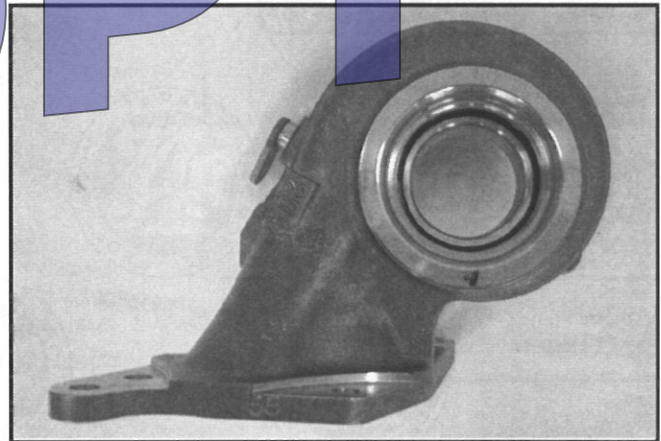

O) Soupape et montage du by-pass du turbocompresseur  
Valve and by-pass installation of turbocharger  
バルブとバイパスのターボチャージャーへの取付位置

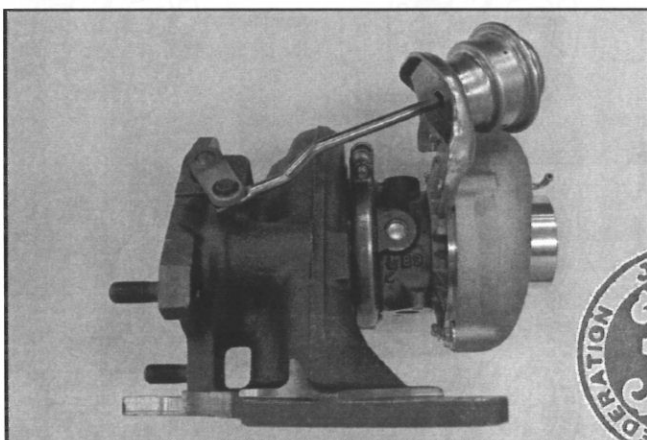

P) Système d'échappement entre collecteur et turbocompresseur  
Exhaust system between manifold and turbocharger  
ターボコンプレッサとマニホールド間の排気方式

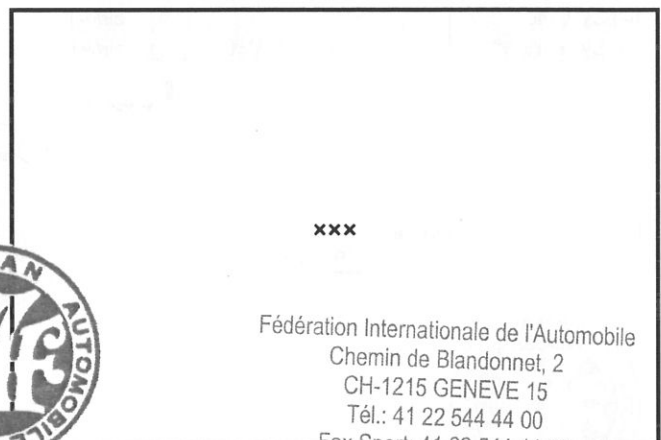

xxx

Fédération Internationale de l'Automobile  
Chemin de Blandonnet, 2  
CH-1215 GENEVE 15  
Tél.: 41 22 544 44 00  
Fax Sport: 41 22 544 44 50



Marque  
Make  
会社名 FUJI

Modèle  
Model  
モデル GRB

Homologation N°

N-5714

Extension N°

09/05 VO

JAF公認番号

FN-085 VO-10/5

- Q) Carter de compression du turbocompresseur  
Compressor housing of turbocharger ターボチャージャーのコンプレッサハウジング

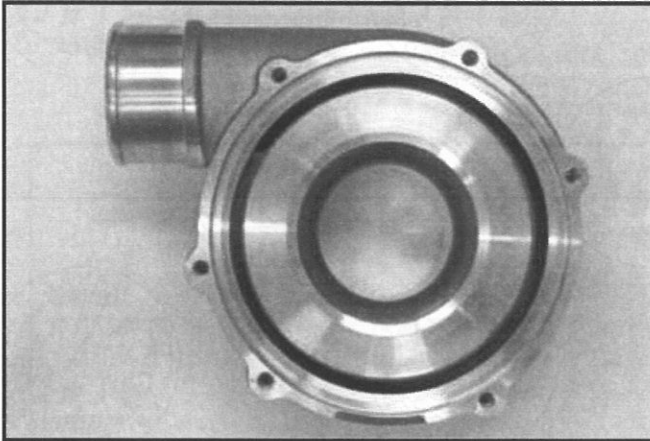

- R) Echangeur intermédiaire déposé  
Intercooler dismounted 取り外したインタークーラー

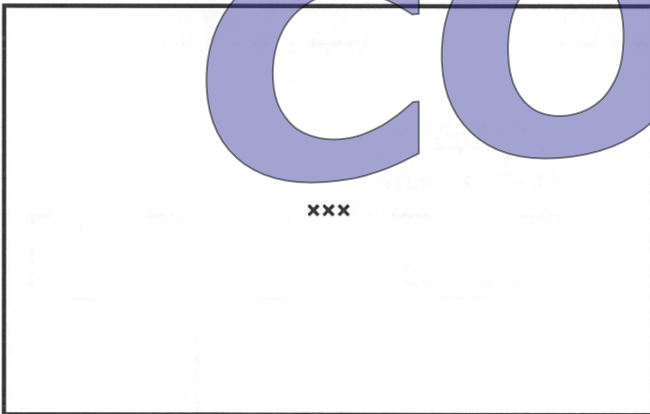

- Z) Echangeur intermédiaire monté  
Intercooler mounted 取り付けしたインタークーラー

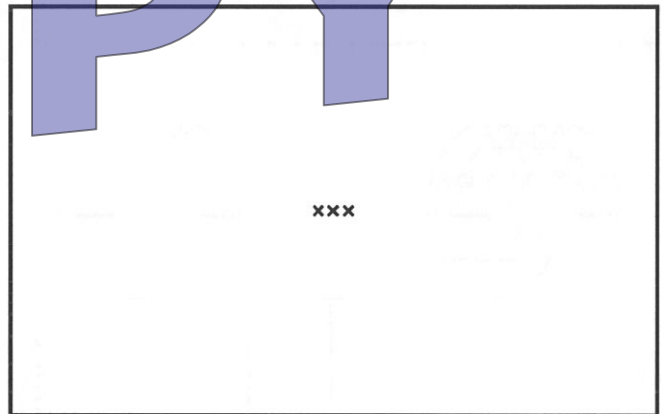

Dessin de l'échangeur avec dimensions  
Drawing of the intercooler with dimensions 寸法を伴ったインタークーラーの図



Fédération Internationale de l'Automobile  
Chemin de Blandonnet, 2  
CH-1215 GENEVE 15  
Tél.: 41 22 544 44 00  
Fax Sport: 41 22 544 44 50

Marque  
Make  
会社名 FUJI

Modèle  
Model  
型名 GRB

Homologation N°

N-5714

Extension N°

09/05 VO

JAF公認番号

FN-085 VO-10/5

## DESSINS / DRAWINGS / 図解

- V) Entrée des gaz d'échappement dans turbine de compresseur  
Exhaust gas inlet to the compressor turbine  
ターボチャージャーコンプレッサの排気入口図

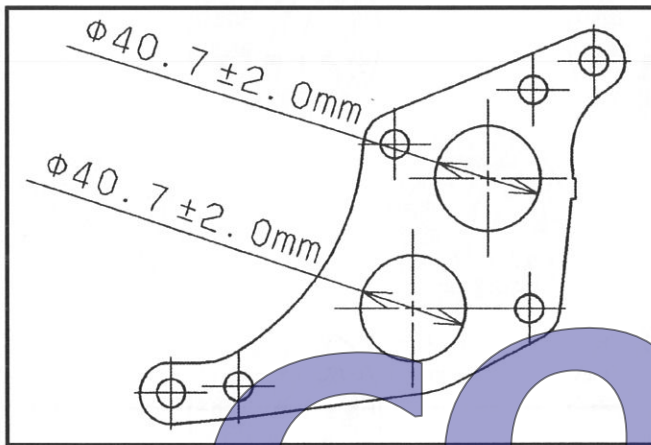

- VI) Sortie des gaz d'échappement de turbine de compresseur  
Exhaust gas outlet from the compressor turbine  
ターボチャージャーコンプレッサの排気出口図

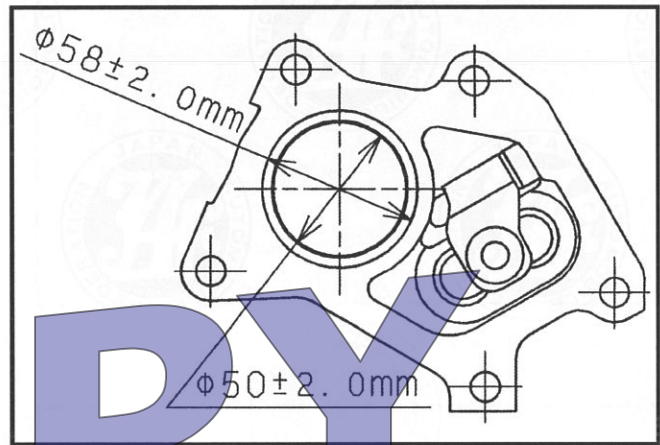

- VII) Entrée d'air (mélange) dans carter de compresseur  
Air (gas) inlet to the compressor housing  
コンプレッサハウジングの入口図

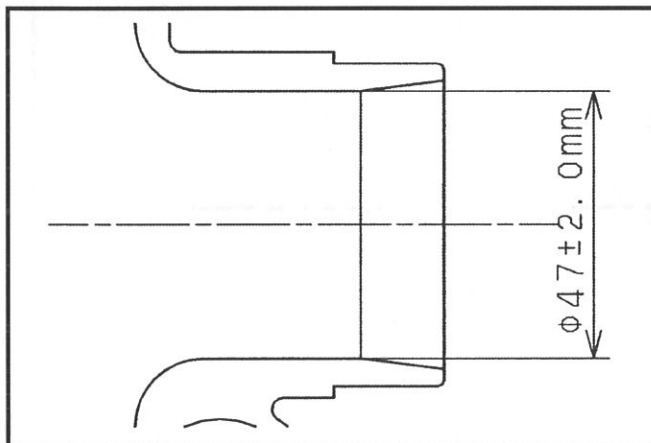

- VIII) Sortie d'air (mélange) du carter de compresseur  
Air (gas) outlet from the compressor housing  
コンプレッサハウジングの出口図

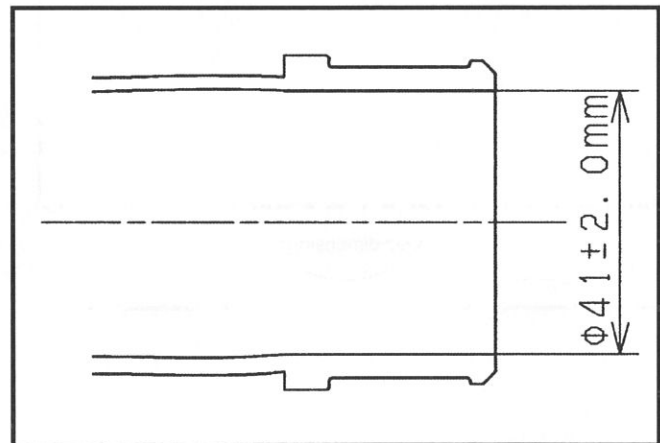

Fédération Internationale de l'Automobile  
Chemin de Blandonnet, 2  
CH-1215 GENEVE 15  
Tél.: 41 22 544 44 00  
Fax Sport: 41 22 544 44 50



Marque  
Make  
会社名 FUJI

Modèle  
Model  
行名 GRB

Homologation N°

N-5714

Extension N°

09/05 VO

JAF公認番号

FN-085 VO-10/5

IX) DISPOSITIF REGLANT LA PRESSION DE SURALIMENTATION  
DEVICE REGULATING THE TURBOCHARGER PRESSURE 過給圧力の調整装置図

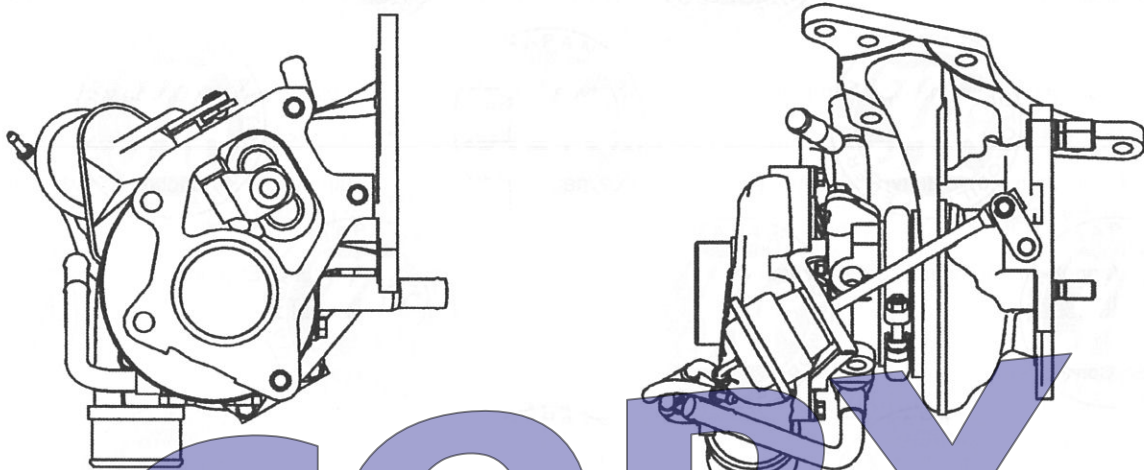

Pression standard

Standard pressure  $0.85 \pm 0.08$  bar

標準過給圧力

Procédure de contrôle de la pression

Procedure for checking the pressure

過給圧力の検査手順

PRESSURE CORRESPONDING TO AN

AXIAL DISPLACEMENT OF THE WASTE GATE CONTROL ROD OF 6.0mm

XV) SYSTEME DE REFROIDISSEMENT DE L'INTERCOOLER  
INTERCOOLER COOLING SYSTEM インタークーラーの冷却方式図

xxx



Fédération Internationale de l'Automobile  
Chemin de Blandonnet, 2  
CH-1215 GENEVE 15  
Tél.: 41 22 544 44 00  
Fax Sport: 41 22 544 44 50



FEDERATION INTERNATIONALE  
DE L'AUTOMOBILE

JAPAN AUTOMOBILE FEDERATION

社団法人 日本自動車連盟

Groupe / Group / グループ

**N**

Homologation N°

**N-5714**

Extension N°

**10/05 ER**

**NON VALABLE EN SUPER PRODUCTION**  
**NOT VALID IN SUPER PRODUCTION**

JAF公認番号 **FN-085 ER-11/5**

JAF発効日 **2009年3月1日**

FICHE D'EXTENSION D'HOMOLOGATION  
HOMOLOGATION EXTENSION FORM

追加公認書式

- |                                    |   |   |  |
|------------------------------------|---|---|--|
| <input type="checkbox"/> <b>ES</b> | Evolution sportive du type / Sporting evolution of the type<br>スポーツ進化 | <input type="checkbox"/> <b>VO</b>            | Variante option / Option variant<br>オプション変型              |
| <input type="checkbox"/> <b>ET</b> | Evolution normale du type / Normal evolution of the type<br>型式の正常進化   | <input type="checkbox"/> <b>VP</b>            | Variante de Production / Production variant<br>生産オプション変型 |
| <input type="checkbox"/> <b>VF</b> | Variante de fourniture / Supply variant<br>供給変型                       | <input checked="" type="checkbox"/> <b>ER</b> | Erratum / Erratum<br>誤記訂正                                |

Véhicule : Constructeur

Vehicle : Manufacturer

車両 : 製造会社名

**FUJI HEAVY INDUSTRIES LTD.**

Modèle et type

Model and type

モデルと型式

**SUBARU IMPREZA WRX STI (2007) , GRB**

Homologation valable à partir du

Homologation valid as from

FIA公認発効年月日

**01 MARS 2009**

**COPY**

| Page or ext.<br>頁または追加番号 | Article<br>項目 | Description<br>記述   |
|--------------------------|---------------|---|
| 08/04VO                  | 9             | <b>BODY WORK</b><br><br><b>Removable unused supports</b><br><b>(Any other parts than parts listed on page 2 and 3 may not be removed)</b> |



Fédération Internationale de l'Automobile  
Chemin de Blandonnet, 2  
CH-1215 GENEVE 15  
Tél.: +41 22 544 44 00  
Fax Sport: +41 22 544 44 50

Marque  
Make  
会社名 **FUJI**

Modèle  
Model  
行名 **GRB**

Homologation N°

**N-5714**

Extension N°

**10/05 ER**

JAF公認番号

**FN-085 ER-11/5**

| Page or ext.<br>頁または追加番号 | Article<br>項目 | Description<br>記述 |
|--------------------------|---------------|-------------------|
|--------------------------|---------------|-------------------|

| Photo No.     | PART NAME  | PART No.   | FOR                            | MASS(kg)    |
|---------------|--|------------|--------------------------------|-------------|
| 0805301 1 / 2 | BRKT OUT TEMP  | 53051FE000 | Temperature sensor             | 0.024       |
| 0805302_1     | BRKT INPN CTR CP & BRKT CP EVAPO                             | -          | Floor carpet & Air conditioner | -           |
| 0805302 2     | BRKT INPN CTR CP   | 52730TC040 | Floor carpet                   | 0.024       |
| 0805302 3     | BRKT CP EVAPO  | 52230AG090 | Air conditioner                | 0.01        |
| 0805303 1 / 2 | BRKT FOOT REST CP RHD  | 52230AG170 | Foot rest                      | 0.044       |
| 0805304 1 / 2 | BRKT MAP LAMP  | 53720FG010 | Map lamp                       | 0.122       |
| 0805305_1 / 2 | PLATE ANCHOR CP LH   | 52135AG160 | Rear seat belts                | 0.29        |
|               | PLATE ANCHOR CP RH   | 52135AG060 | Rear seat belts                | 0.29        |
| 0805306 1     | HOOK TIE DOWN R (LHside)                                     | 57801FG000 | Tie down                       | 0.26        |
| 0805306 2     | HOOK TIE DOWN R (RHside)                                     | 57801FG000 | Tie down                       | 0.26        |
| 0805306 1 / 2 | HOOK TIE DOWN R (LHside & RHside)                            | -          | Tie down                       | -           |
| 0805307 1 / 2 | BRKT CANISTER  | 52152FG020 | Canister                       | 0.064       |
| 0805308 1     | REINF SP TIRE CP & BRKT SP TIRE CP                           | -          | Canister                       | -           |
| 0805308 2     | REINF SP TIRE CP   | 52143FG000 | Spare tyre                     | 0.424       |
| 0805308 3     | BRKT SP TIRE CP  | 52152FG000 | Spare tyre                     | 0.216       |
| 0805309 1 / 2 | PATCH CRSMR B CP   | 52136AG210 | Rear seat                      | 0.036       |
| 0805310 1     | BRKT ECU B (LHside)  | 53230TC180 | Inner trims                    | 0.012       |
| 0805310 2     | BRKT ECU B (RHside)  | 53230TC180 | Inner trims                    | 0.012       |
| 0805310 3     | BRKT ECU B (RHside & LHside)                                 | -          | Inner trims                    | -           |
| 0805311 1 / 2 | REINF RETRACTER  | 51572FG100 | Rear seat belts                | 0.036       |
| 0805312 1     | BRKT TRIM R QTR (RHside)                                     | 51562FG040 | Inner trims                    | 0.038       |
| 0805312 2     | BRKT TRIM R QTR (LHside)                                     | 51562FG040 | Inner trims                    | 0.038       |
| 0805312 3     | BRKT TRIM R QTR (RHside & LHside)                            | -          | Inner trims                    | -           |
| 0805313_1     | BRKT MUF A + HOOK MUF CTR & BRKT MUF B + HOOK MUF B (LHside) | -          | Exhaust pipe                   | -           |
| 0805313_2     | BRKT MUF A (LHside)  | 52153FG000 | Exhaust pipe                   | 0.102       |
|               | HOOK MUF CTR (LHside)  | 52148AE000 |                                |             |
| 0805313_3     | BRKT MUF B (LHside)  | 52153FG030 | Exhaust pipe                   | 0.138       |
|               | HOOK MUF B (LHside)  | 52148FG010 |                                |             |
| 0805314_1     | BRKT MUF A + HOOK MUF CTR & BRKT MUF B + HOOK MUF B (RHside) | -          | Exhaust pipe                   | -           |
| 0805314_2     | BRKT MUF A (RHside)  | 52153FG000 | Exhaust pipe                   | 0.102       |
|               | HOOK MUF CTR (RHside)  | 52148AE000 |                                |             |
| 0805314_3     | BRKT MUF B (RHside)  | 52153FG020 | Exhaust pipe                   | 0.138       |
|               | HOOK MUF B (RHside)  | 52148FG010 |                                |             |
|               |  |            | <b>SUB TOTAL</b>               | <b>2.68</b> |



Fédération Internationale de l'Automobile  
Chemin de Blandonnet, 2  
CH-1215 GENEVE 15  
Tél.: 41 22 544 44 00  
Fax Sport: 41 22 544 44 50

Marque  
Make  
会社名 **FUJI**

Modèle  
Model  
行名 **GRB**

Homologation N°

**N-5714**

Extension N°

**10/05 ER**

JAF公認番号

**FN-085 ER-11/5**

| Page or ext.<br>頁または追加番号 | Article<br>項目 | Description<br>記述 |                       |                |   |                     |
|--------------------------|---------------|-------------------|-----------------------|----------------|---|---------------------|
|                          |               | <b>Photo No</b>   | <b>PART NAME</b>      | <b>PART No</b> | <b>FOR</b>  | <b>MASS (kg)</b>    |
|                          |               | 0902311_1 / 2 / 3 | HOOK TIE DOWN         | 51681AG000     | TIE DOWN  | (0.237kax 2 ) 0.474 |
|                          |               | 0902312_1 / 2     | COVER COMPL T/B RHD   | 52240AG000     | NOISE & HEAT PROTECTION   | 0.507               |
|                          |               | 0902313_1 / 3     | STAY CP COWL SD LH    | 50866FG050     |   | 0.408               |
|                          |               | 0902313_1 / 3     | PILOT BOLT            | - 010110200    | SUPPORT   | (0.020kax 4 ) 0.080 |
|                          |               | 0902313_2 / 3     | STAY CP COWL SD RH    | 50866FG040     |   | 0.404               |
|                          |               | 0902313_2 / 3     | PILOT BOLT            | - 010110200    |   | (0.020kax 4 ) 0.080 |
|                          |               | 0902314_1 / 2     | PLATE COMPL           | 35038AG081     | RUBBER BOOTS  | 0.387               |
|                          |               | 0902315_1 / 2     | CROSS MBR F/ S F C LH | 52140AG180     |   | 0.910               |
|                          |               | 0902315_1 / 2     | CROSS MBR FS R CP LH  | 52140AG210     | SEAT MOUNTING<br>(It may removed only when<br>replaced by welded seat mountings )   | 0.764               |
|                          |               | 0902316_1 / 2     | CROSS MBR F/ S F C RH | 52140AG160     |   | 0.938               |
|                          |               | 0902316_1 / 2     | CROSS MBR FS R CP RH  | 52140AG200     |   | 0.762               |
|                          |               | 0902317_1 / 2     | BRACE A               | 53701FG010     | SUPPORT   | 0.238               |
|                          |               | 0902317_1 / 2     | BRACE B               | 53701FG020     | SUPPORT   | 0.234               |
|                          |               | 0902318_1 / 3     | BRKT HARNESS LH       | 52152AG030     |   | 0.064               |
|                          |               | 0902318_2 / 3     | BRKT HARNESS RH       | 52152AG020     | WIRING HARNESS  | 0.064               |
|                          |               | 0902318_1 / 2 / 3 | FLANGE BOLT           | - 10108160     |   | (0.012kax 4 ) 0.048 |
|                          |               | 0902319_1 / 2     | BRKT SENSOR           | 20172FG100     | SENSOR  | 0.066               |
|                          |               | 0902320_1 / 3     | PLR COMPL CTR IN LH   | 51530FG010     | SEAT BELT<br>(It may be Removed only when the<br>original seat belt is replaced by<br>FIA homologated type)                                   | 0.044               |
|                          |               | 0902320_2 / 3     | PLR COMPL CTR IN RH   | 51530FG000     |   | 0.046               |
|                          |               | 0902321_1 / 2     | BRKT H/ B CABLE       | 52153AG380     | HAND BRAKE CABLE<br>(It may be Removed only when the<br>original hand brake system is replaced<br>by FIA homologated hydraulic hand<br>brake) | 0.022               |
|                          |               | 0902322_1 / 3     | BRKT HAND B CBL R LH  | 52152FG120     |   | 0.042               |
|                          |               | 0902322_2 / 3     | BRKT HAND B CBL R RH  | 52152FG110     |   | 0.042               |
|                          |               | 0902323_1 / 2     | COVER CANISTER LH     | 42054FG010     | CANISTER COVER  | 1.324               |
|                          |               | 0902323_1 / 2     | COVER CANISTER RH     | 42054FG000     |   | 1.484               |
|                          |               | 0902323_1 / 2     | COVER CANISTER CTR    | 42054FG020     |   | 0.362               |
|                          |               | 0902323_1 / 2     | BOLT                  | - 010108160    |   | (0.020kax 4 ) 0.080 |
|                          |               | 0902323_1 / 2     | NUT                   | - 023808000    |   | (0.012kax 4 ) 0.048 |
|                          |               | 0902324_1 / 2     | GUSSET R APRON LH     | 52163FG010     | SUPPORT   | 0.541               |
|                          |               | 0902325_1 / 2     | GUSSET R APRON RH     | 52163FG000     |   | 0.521               |
|                          |               | 0902326_1 / 2     | BRKT COV EXH R CP     | 52153AB030     | FUEL FILLER PIPE  | 0.010               |
|                          |               | 0902327_1 / 2     | BRKT TRACTIVE CP      | 57803FG000     | TOEING  | 1.242               |
|                          |               | 0902327_1 / 2     | NUT                   | - 902370042    |   | (0.012kax 3 ) 0.036 |
|                          |               | 0902328_1 / 2     | PLATE SKIRT LH        | 52432FG030     | COVER   | 0.082               |
|                          |               | 0902329_1 / 2     | PLATE SKIRT RH        | 52432FG020     |   | 0.082               |
|                          |               | 0902329_1 / 2     | NUT                   | - 902370042    |   | (0.012kax 2 ) 0.024 |
|                          |               | 0902330_1 / 2     | COVER EXH CP          | 59020FG010     |   | 0.777               |
|                          |               | 0902331_1 / 2     | COVER FUEL TANK CP    | 42054FG080     | HEAT PROTECTION   | 0.343               |
|                          |               | 0902332_1 / 2     | COVER EXH R           | 59024FG020     |   | 0.413               |
|                          |               |                   |                       |                | <b>SUB TOTAL</b>  | 13.993              |
|                          |               |                   |                       |                | <b>TOTAL</b>  | <b>16.673</b>       |

Fédération Internationale de l'Automobile  
Chemin de Diancourt, 2  
CH-1215 GENEVE 4

Tél.: 41 22 544 44 00  
Fax Sport: 41 22 544 44 50



Marque  
Make  
会社名 **FUJI**

Modèle  
Model  
行名 **GRB**

Homologation N°

**N-5714**

Extension N°

**10/05 ER**

JAF公認番号

**FN-085 ER-11/5**

PHOTO N° 0805301\_1

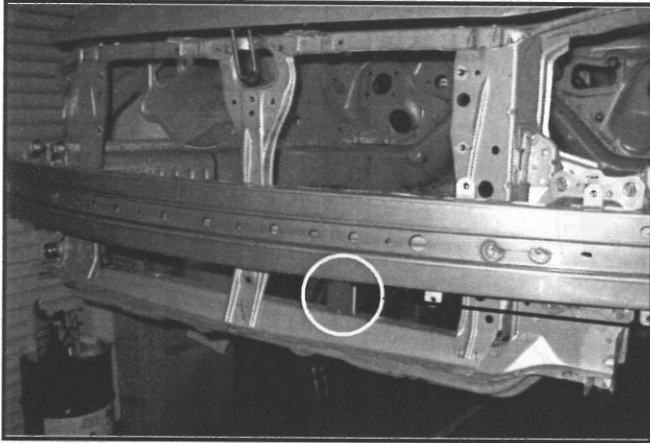

PHOTO N° 0805301\_2

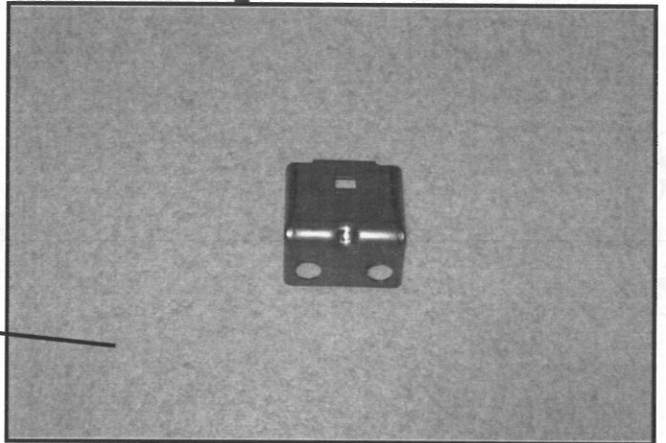

PHOTO N° 0805302\_1

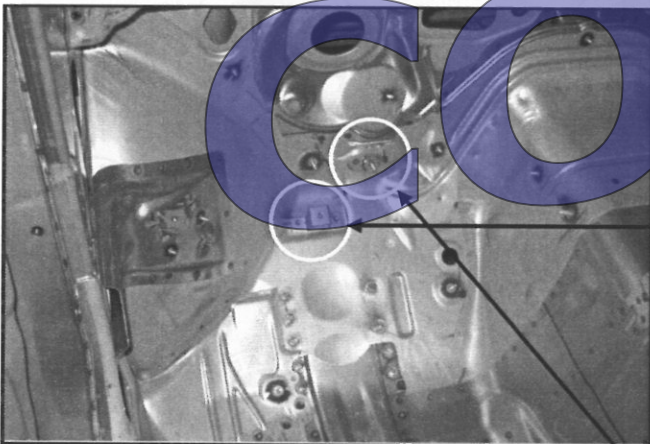

PHOTO N° 0805302\_2

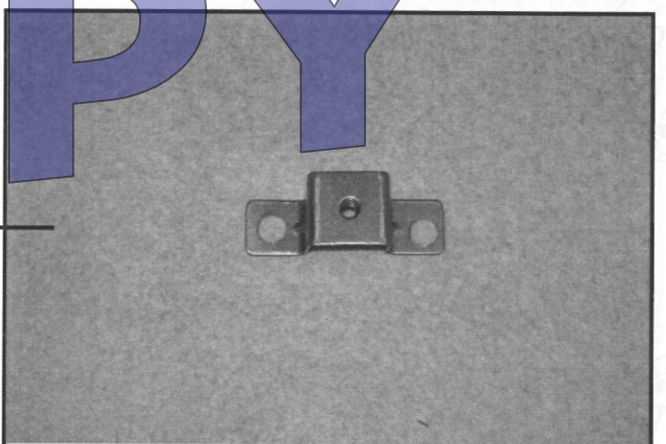

PHOTO N°

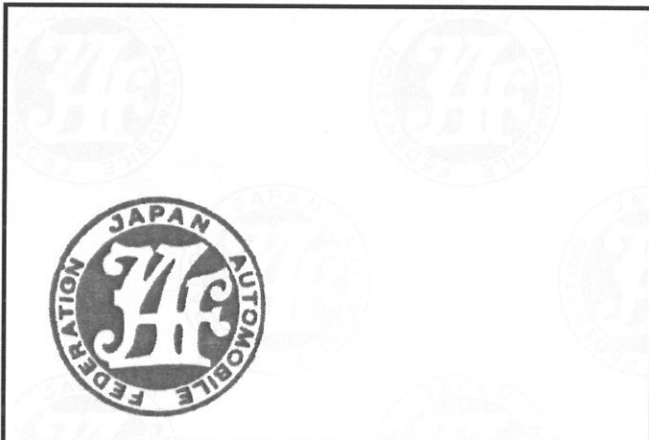
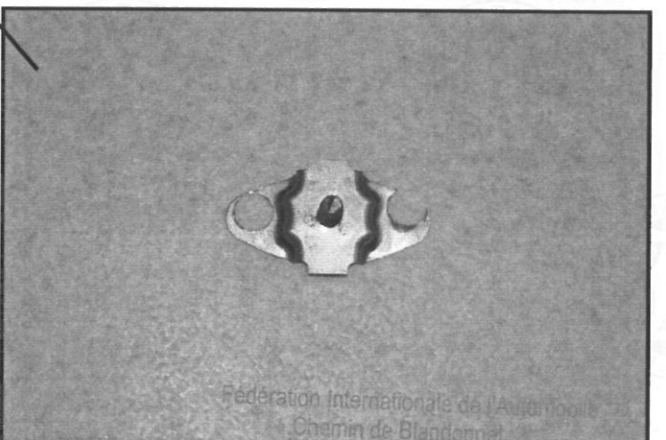

PHOTO N° 0805302\_3



Fédération Internationale de l'Automobile  
Chemin de Blandinnet, 2

CH-1215 GENEVE 15  
Tél.: 41 22 544 44 00  
Fax Sport: 41 22 544 44 50

Marque  
Make  
会社名 **FUJI**

Modèle  
Model  
行名 **GRB**

Homologation N°

**N-5714**

Extension N°

**10/05 ER**

JAF公認番号

**FN-085 ER-11/5**

PHOTO N° 0805303\_1

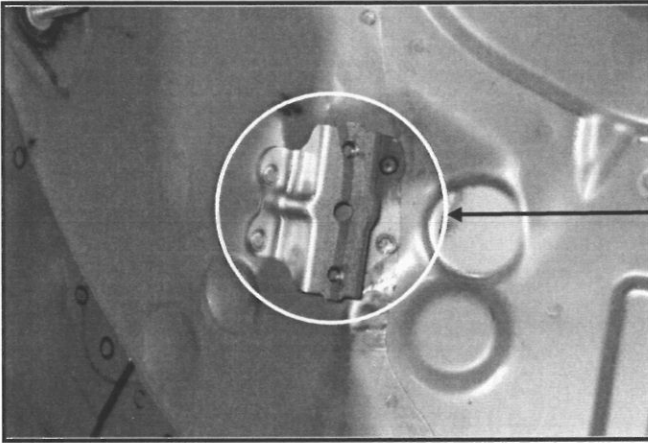

PHOTO N° 0805303\_2

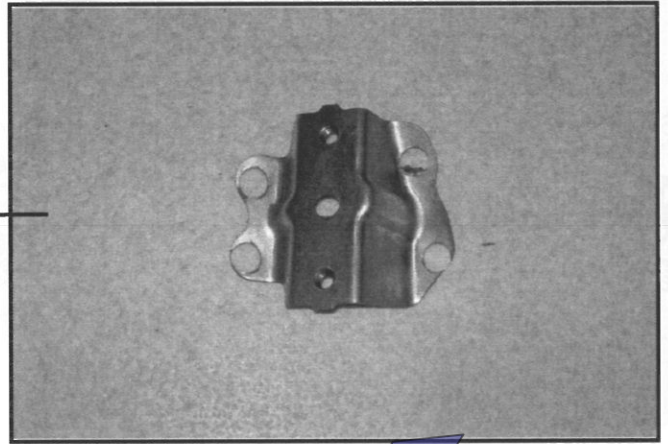

PHOTO N° 0805304\_1

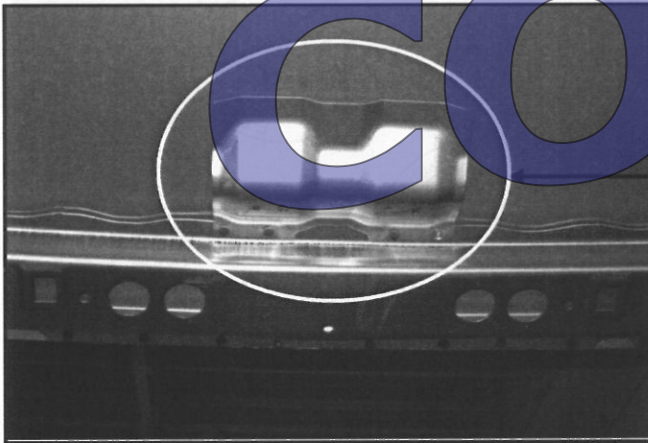

PHOTO N° 0805304\_2

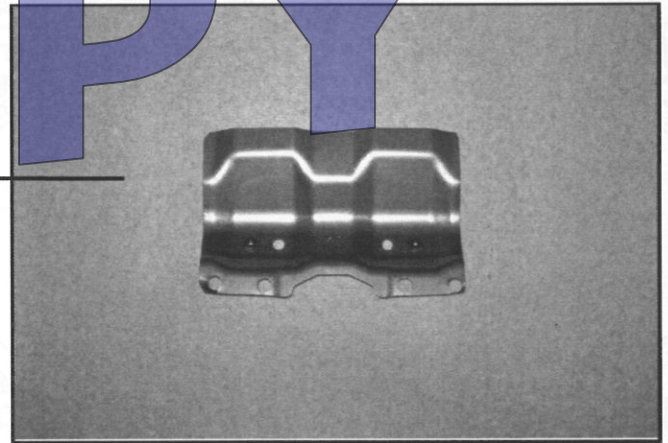

PHOTO N° 0805305\_1

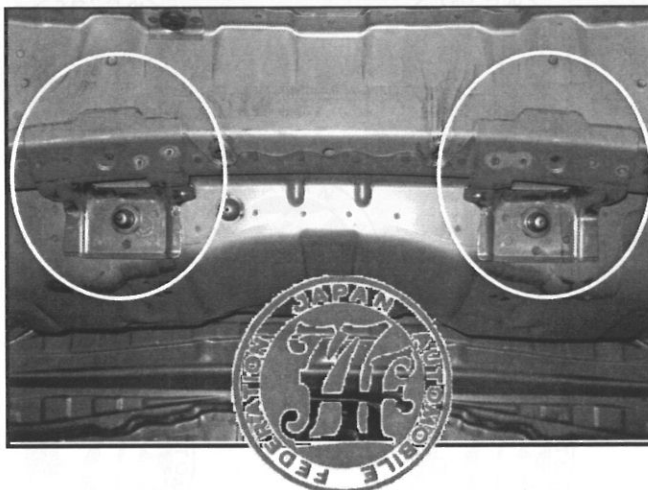
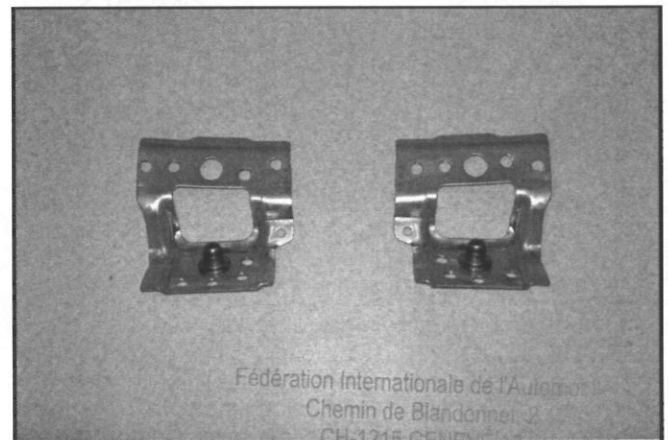

PHOTO N° 0805305\_2



Fédération Internationale de l'Automobile  
Chemin de Blandanet, 2  
CH-1713 GENÈVE 18

Tél.: 41 22 544 44 00  
Fax Sport: 41 22 544 44 50

Marque  
Make  
会社名 **FUJI**

Modèle  
Model  
行名 **GRB**

Homologation N°

**N-5714**

Extension N°

**10/05 ER**

JAF公認番号

**FN-085 ER-11/5**

PHOTO N° 0805306\_1

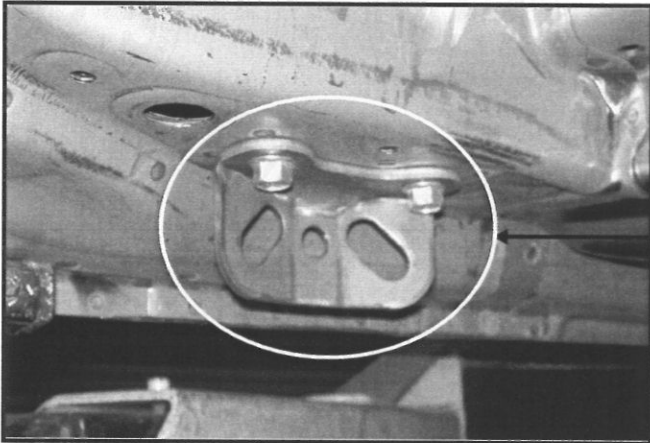

PHOTO N° 0805306\_3

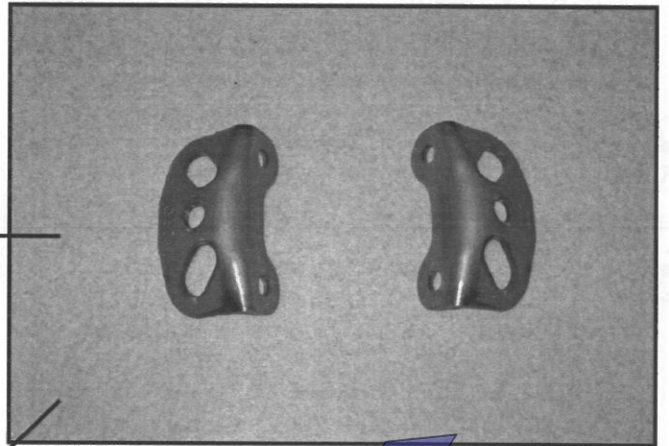

PHOTO N° 0805306-2

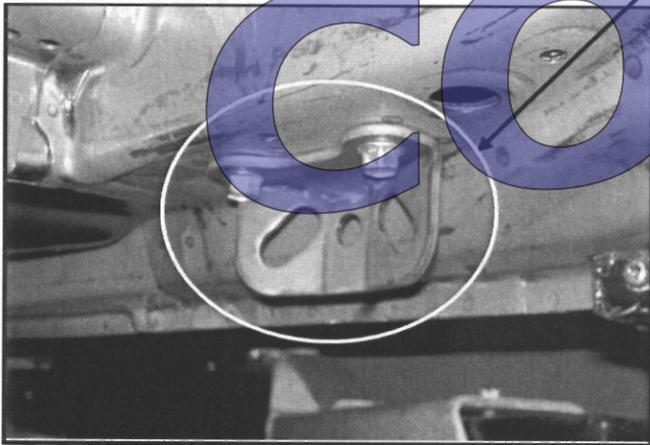

PHOTO N°

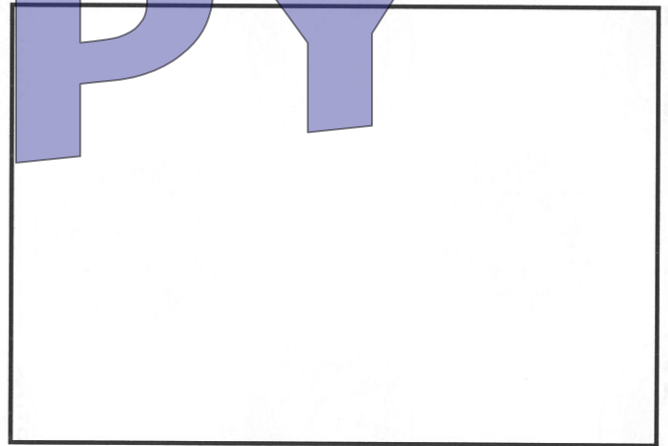

PHOTO N° 0805307\_1

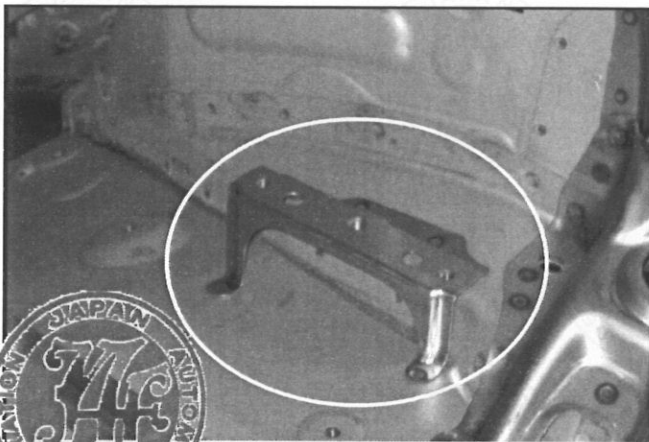
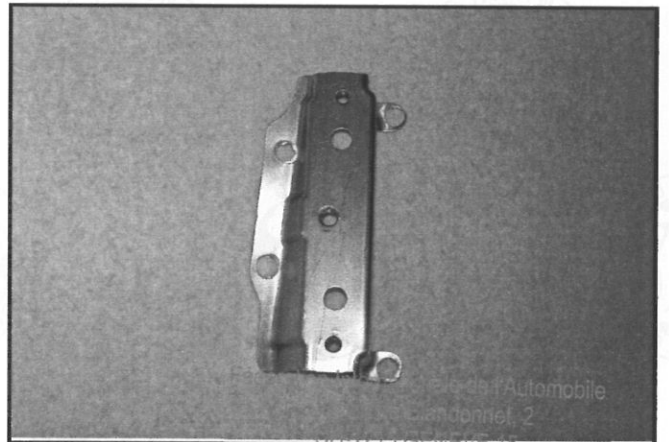

PHOTO N° 0805307\_2



Marque  
Make  
会社名 **FUJI**

Modèle  
Model  
行名 **GRB**

Homologation N°

**N-5714**

Extension N°

**10/05 ER**

JAF公認番号

**FN-085 ER-11/5**

PHOTO N° 0805308\_1

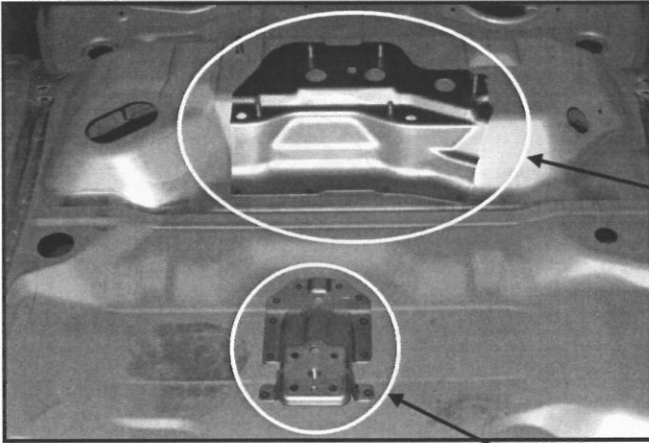

PHOTO N° 0805308\_2

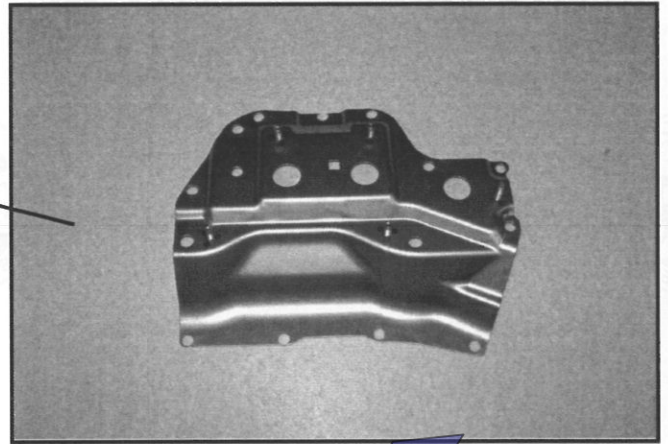

PHOTO N°

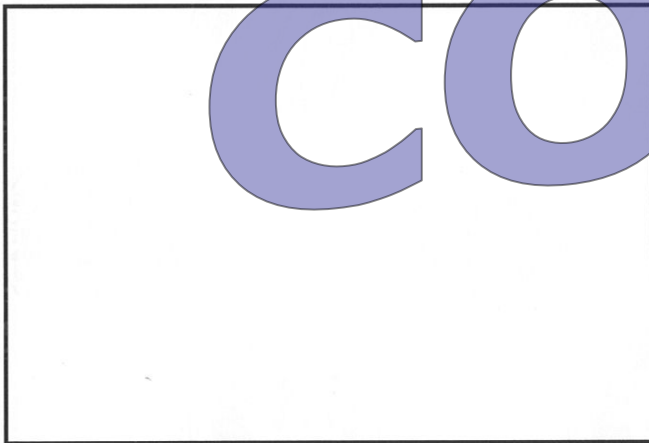

PHOTO N° 0805308\_3

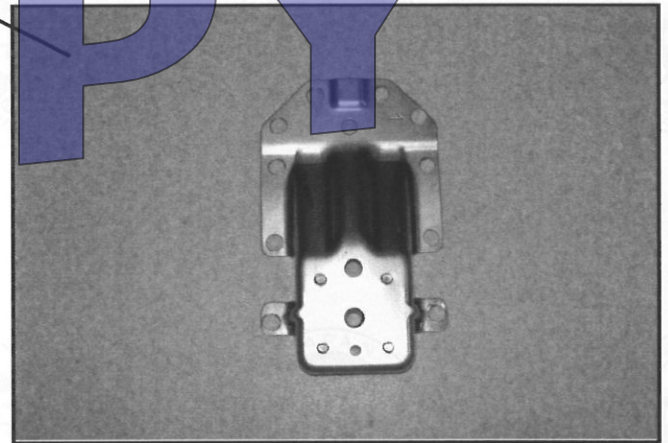

PHOTO N° 0805309\_1

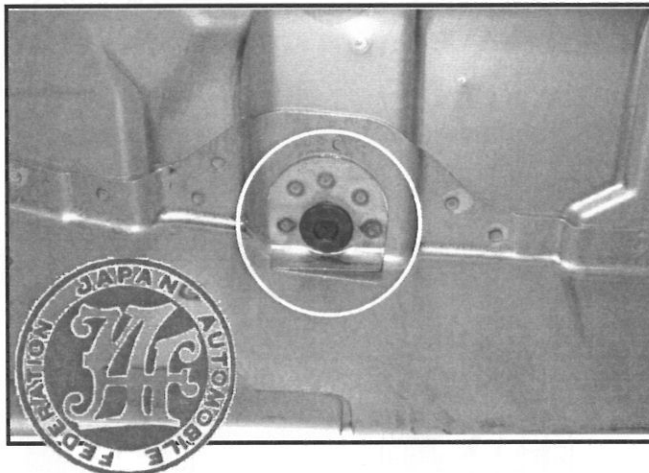
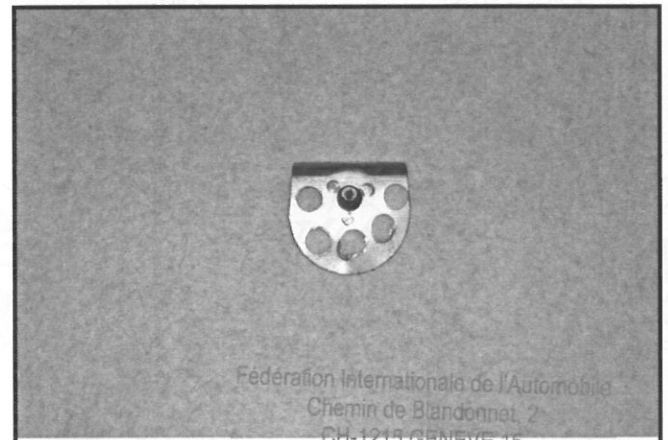

PHOTO N° 0805309\_2



Fédération Internationale de l'Automobile  
Chemin de Blandonnat, 2  
CH-1213 GENEVE 18  
Tél.: 41 22 544 44 00  
Fax Sport: 41 22 544 44 50



Marque  
Make  
会社名 **FUJI**

Modèle  
Model  
型名 **GRB**

Homologation N°

**N-5714**

Extension N°

**10/05 ER**

JAF公認番号

**FN-085 ER-11/5**

PHOTO N° 0805310\_1

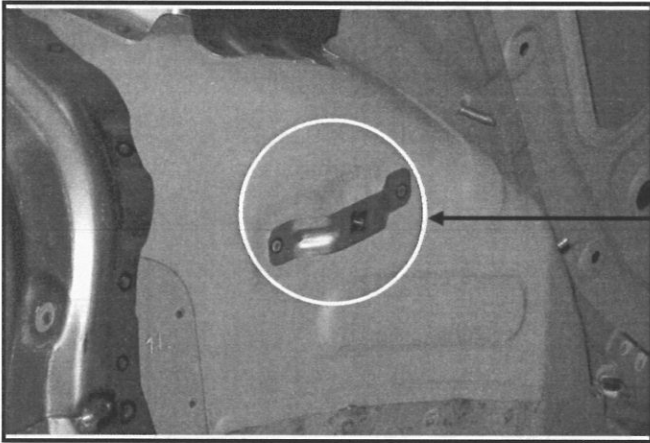

PHOTO N° 0805310\_3

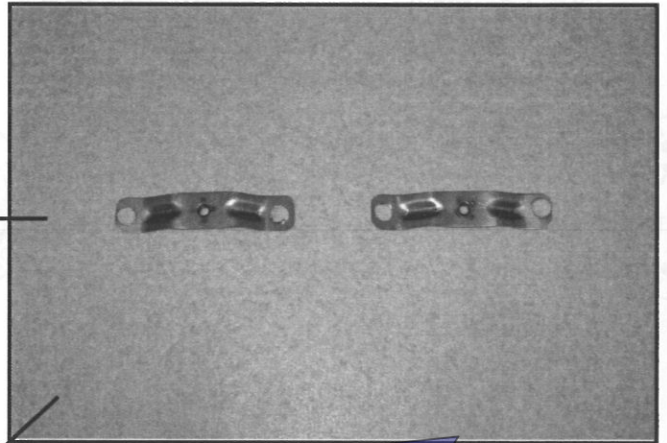

PHOTO N° 0805310\_2



PHOTO N°

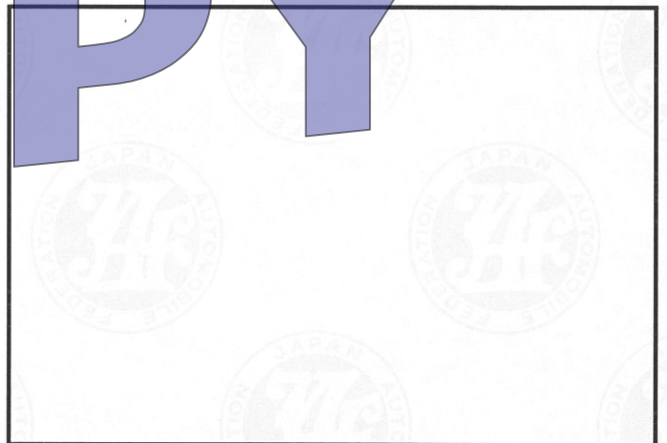

PHOTO N° 0805311\_1

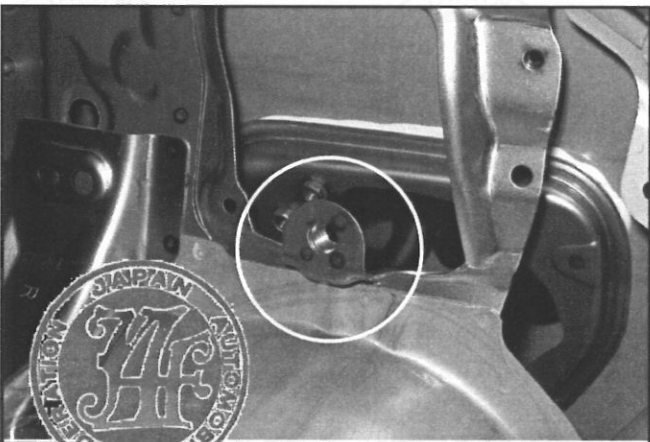
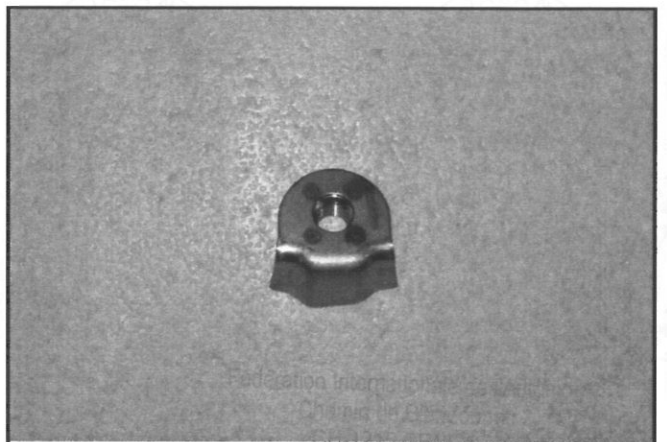

PHOTO N° 0805311\_2



Tél.: 41 22 544 44 00  
Fax Sport: 41 22 544 44 50

Marque  
Make  
会社名 FUJI

Modèle  
Model  
行名 GRB

Homologation N°

**N-5714**

Extension N°

**10/05 ER**

JAF公認番号

**FN-085 ER-11/5**

PHOTO N° 0805312\_1

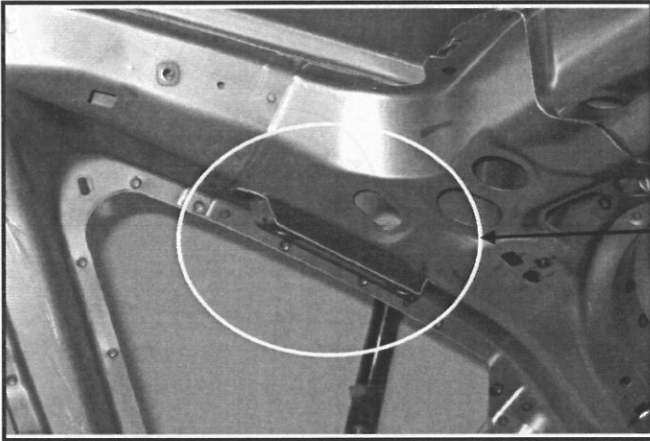

PHOTO N° 0805312\_3

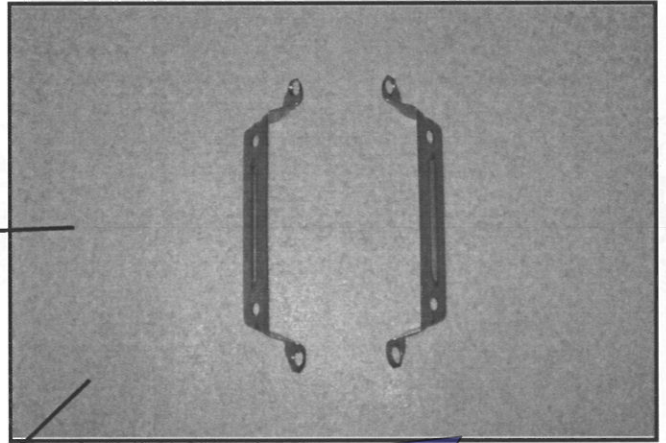

PHOTO N° 0805312\_2

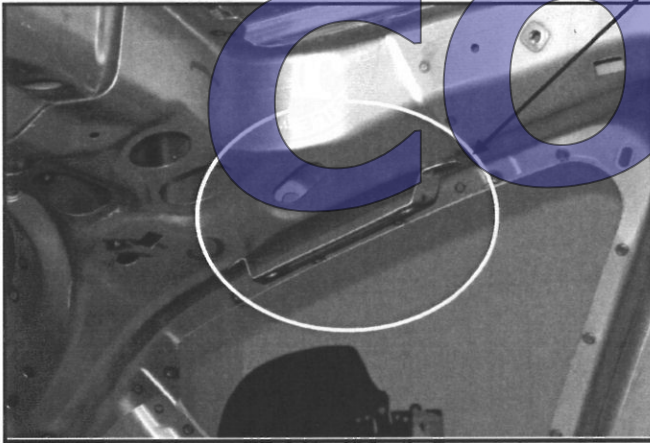

PHOTO N°

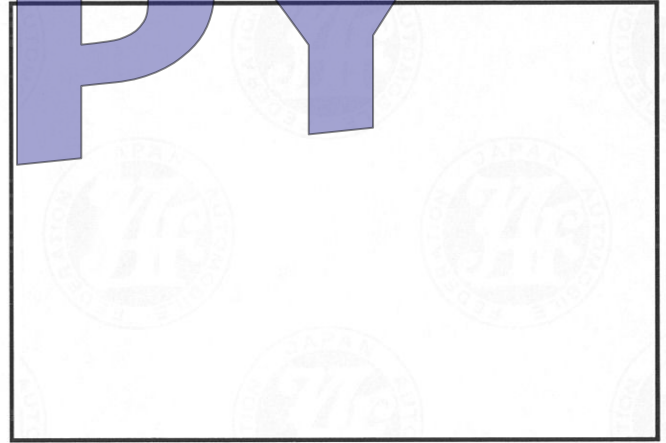

PHOTO N°

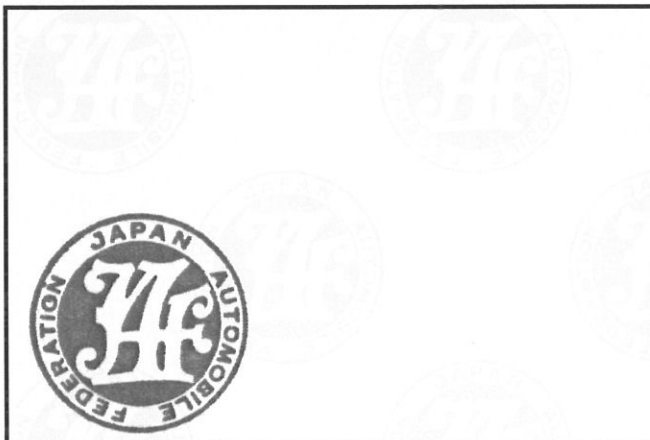
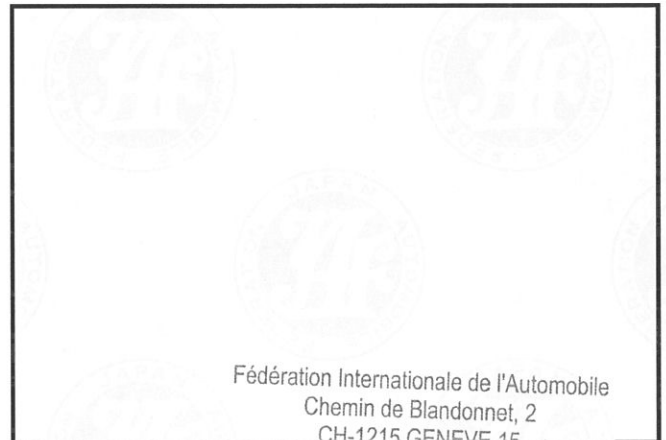

PHOTO N°



Fédération Internationale de l'Automobile  
Chemin de Blandonnet, 2  
CH-1215 GENEVE 15  
Tél.: 41 22 544 44 00  
Fax Sport: 41 22 544 44 50

Marque  
Make  
会社名 **FUJI**

Modèle  
Model  
型名 **GRB**

Homologation N°

**N-5714**

Extension N°

**10/05 ER**

JAF公認番号

**FN-085 ER-11/5**

PHOTO N° 0805313\_1

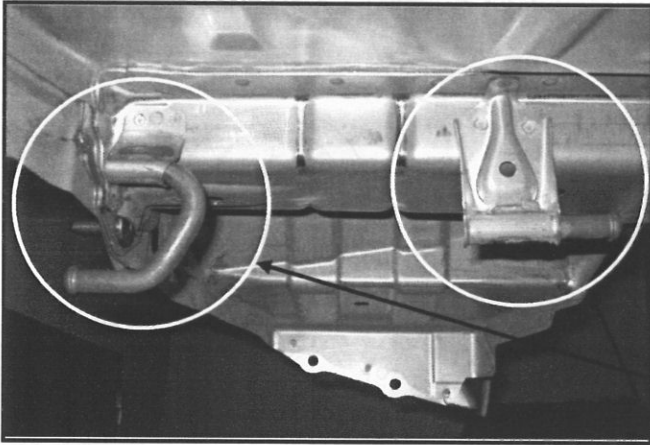

PHOTO N° 0805313\_2

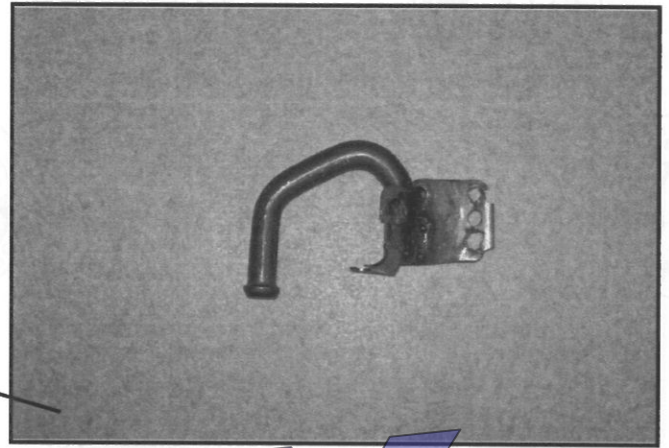

PHOTO N°

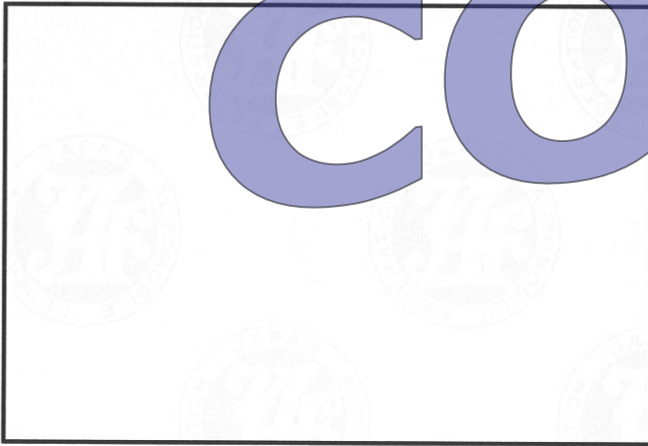

PHOTO N° 0805313\_3

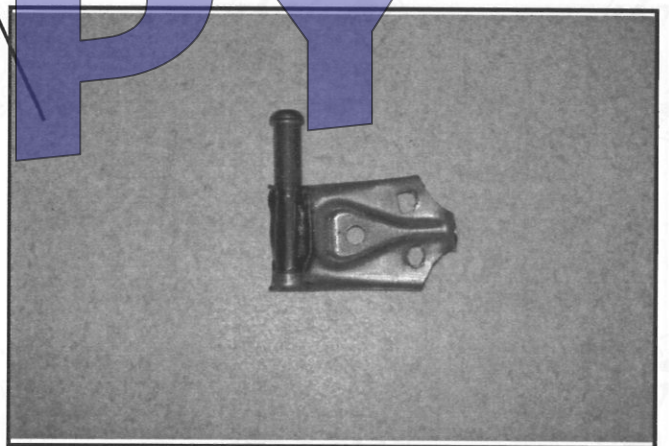

PHOTO N°

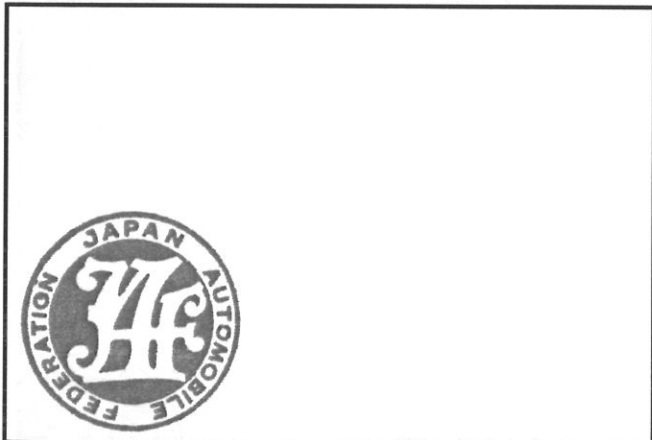

PHOTO N°



Marque  
Make  
会社名 **FUJI**

Modèle  
Model  
行名 **GRB**

Homologation N°

**N-5714**

Extension N°

**10/05 ER**

JAF公認番号

**FN-085 ER-11/5**

PHOTO N° 0805314\_1

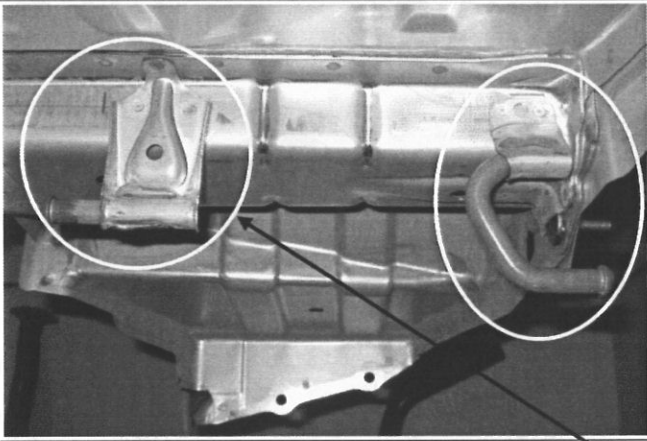

PHOTO N° 0805314\_2



PHOTO N°

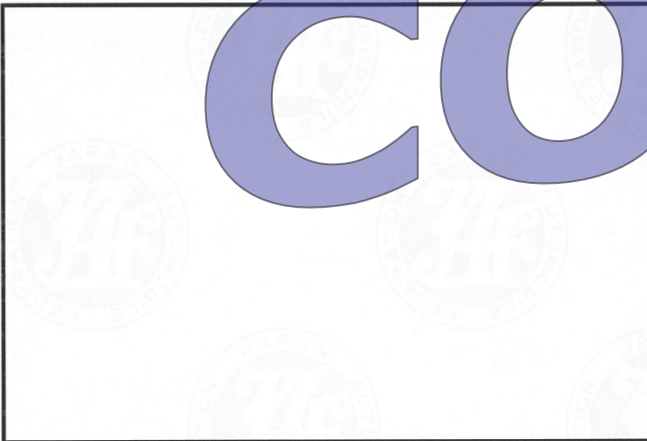

PHOTO N° 0805314\_3

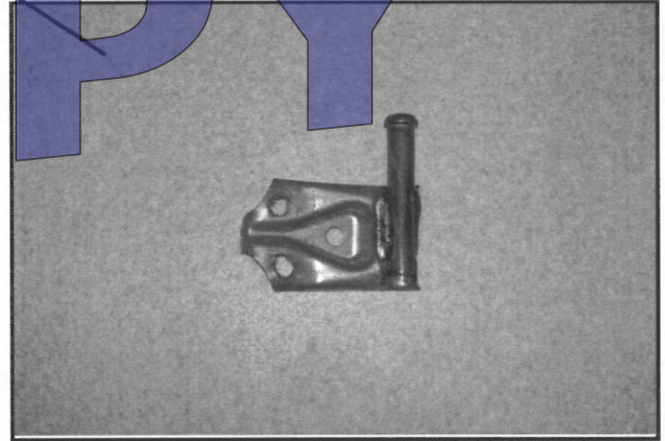
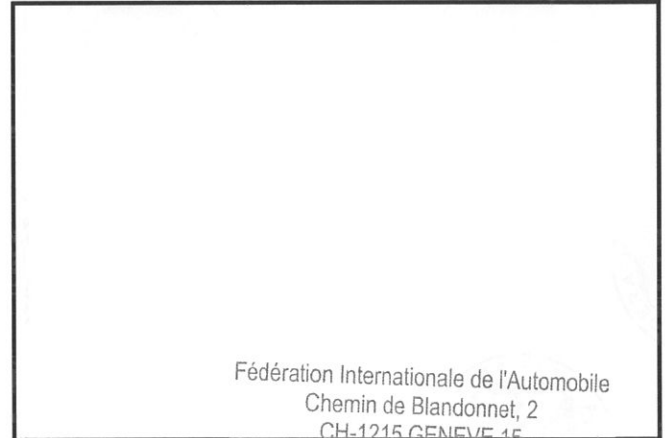

PHOTO N°



PHOTO N°



Fédération Internationale de l'Automobile  
Chemin de Blandonnet, 2  
CH-1215 GENEVE 15  
Tél.: 41 22 544 44 00  
Fax Sport: 41 22 544 44 50

Marque  
Make  
会社名 **FUJI**

Modèle  
Model  
行名 **GRB**

Homologation N°

**N-5714**

Extension N°

**10/05 ER**

JAF公認番号

**FN-085 ER-11/5**

PHOTO N° 0902311\_1

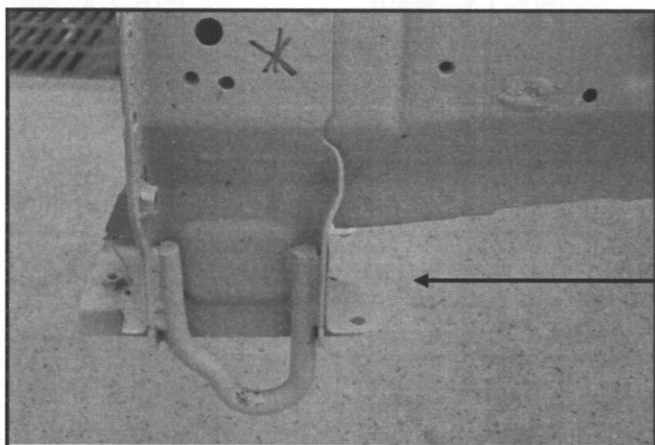

PHOTO N° 0902311\_3

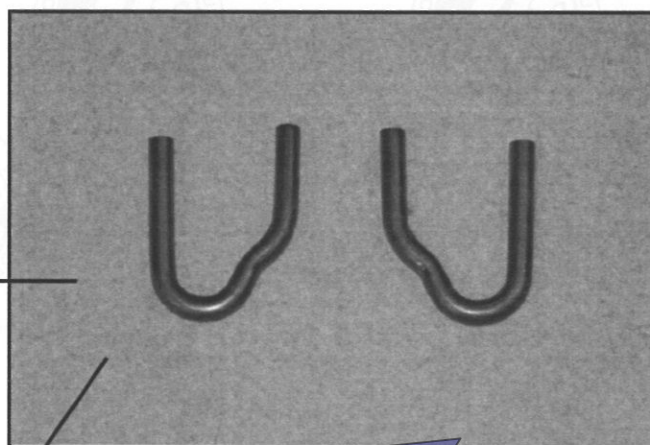

PHOTO N° 0902311\_2

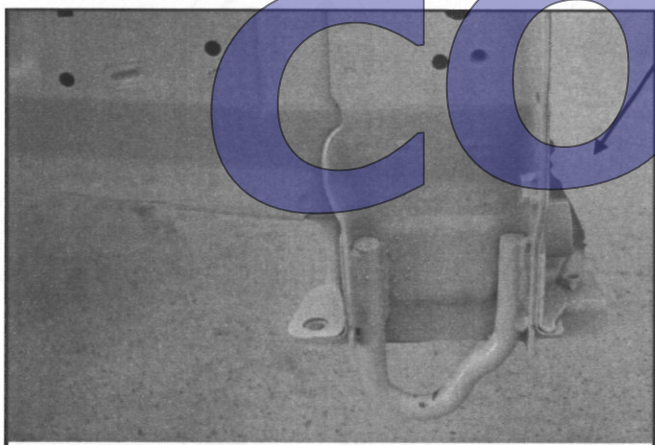

PHOTO N°

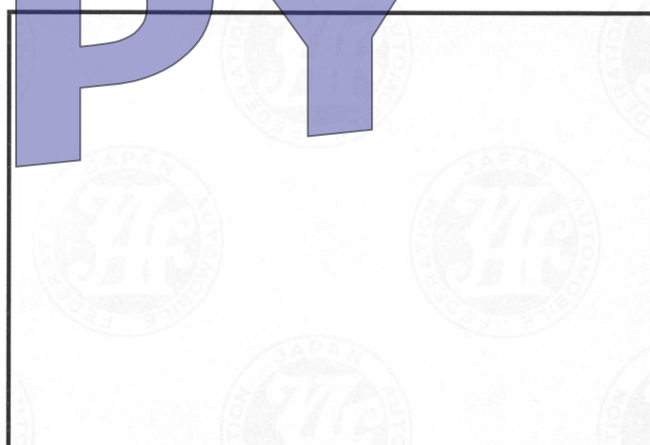
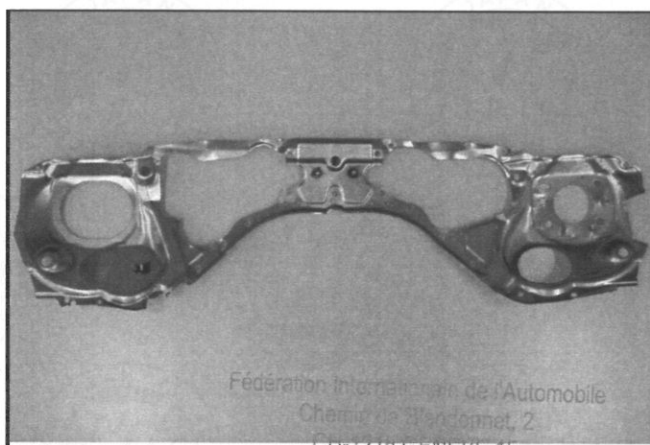

PHOTO N° 0902312\_1



PHOTO N° 0902312\_2



Fédération Internationale de l'Automobile  
Chemin de St-Jacques, 2  
CH-1015 SION, SUISSE

Tél.: 41 22 544 44 00  
Fax Sport: 41 22 544 44 50

Marque  
Make  
会社名 **FUJI**

Modèle  
Model  
行名 **GRB**

Homologation N°

**N-5714**

Extension N°

**10/05 ER**

JAF公認番号

**FN-085 ER-11/5**

PHOTO N° 0902313\_1

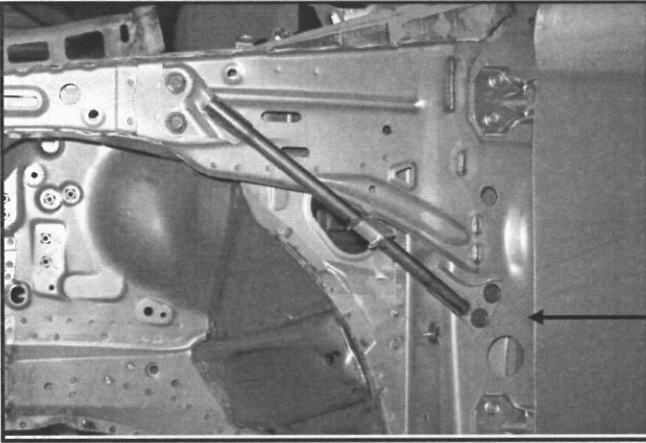

PHOTO N° 0902313\_3

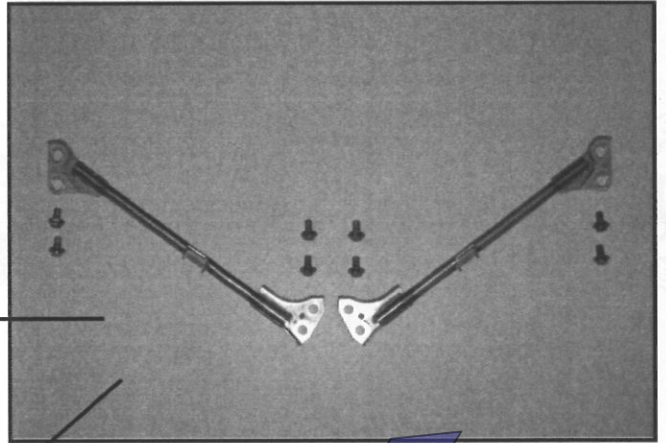

PHOTO N° 0902313\_2

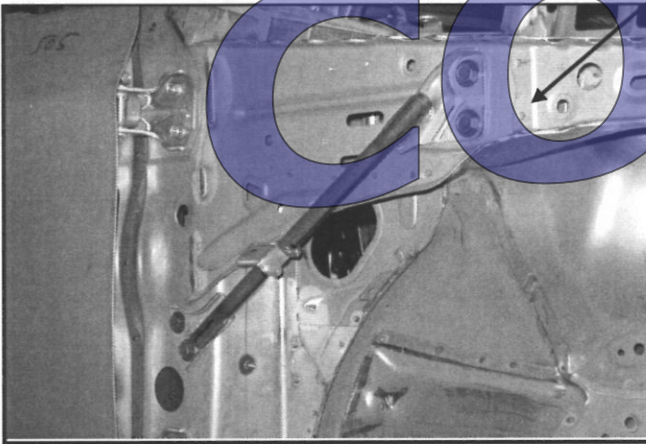

PHOTO N°

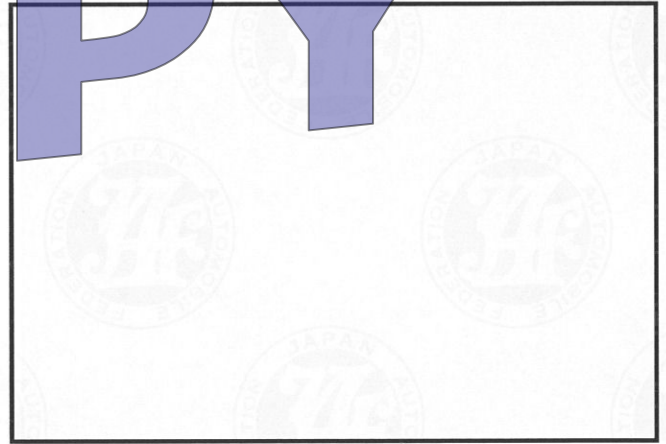

PHOTO N° 0902314\_1

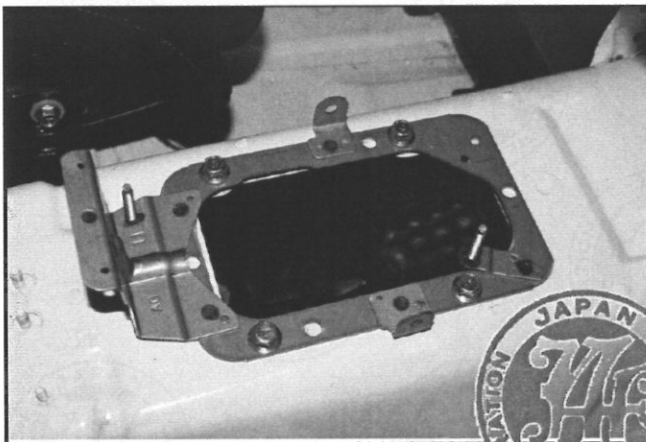
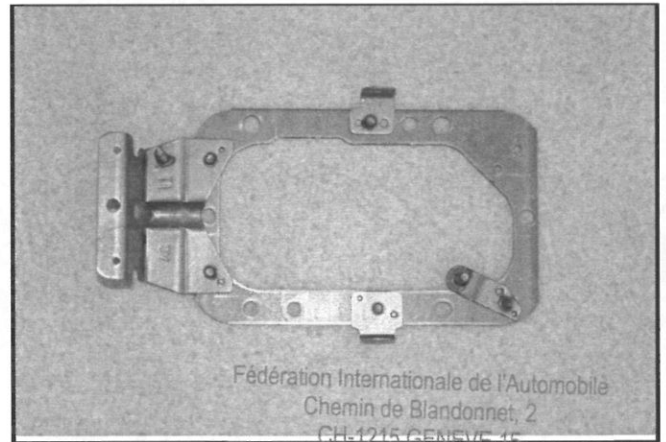

PHOTO N° 0902314\_2



Fédération Internationale de l'Automobile  
Chemin de Blandonnet, 2  
CH-1215 GENEVE 15  
Tél.: 41 22 544 44 00  
Fax Sport: 41 22 544 44 50

Marque  
Make  
会社名 **FUJI**

Modèle  
Model  
車名 **GRB**

Homologation N°

**N-5714**

Extension N°

**10/05 ER**

JAF公認番号

**FN-085 ER-11/5**

PHOTO N° 0902315\_1

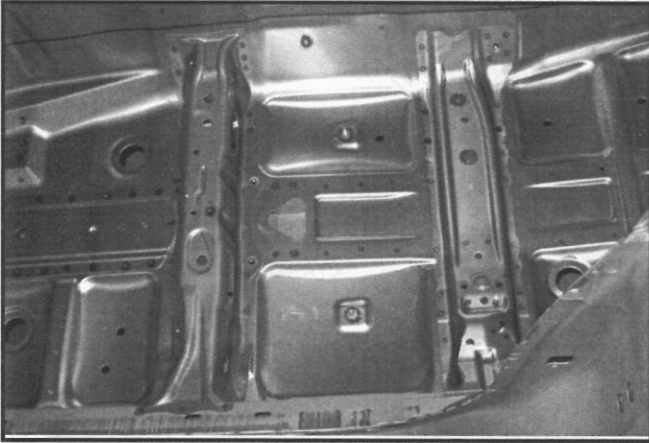

PHOTO N° 0902315\_2

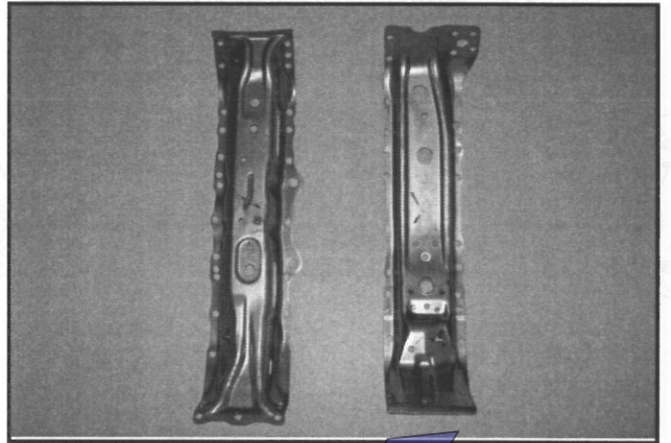

PHOTO N° 0902316\_1

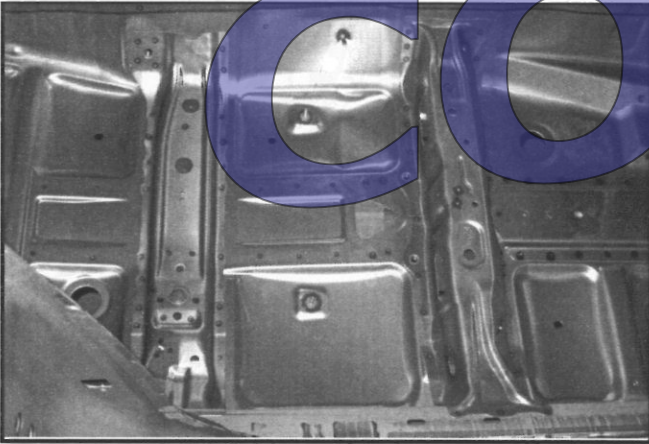

PHOTO N° 0902316\_2

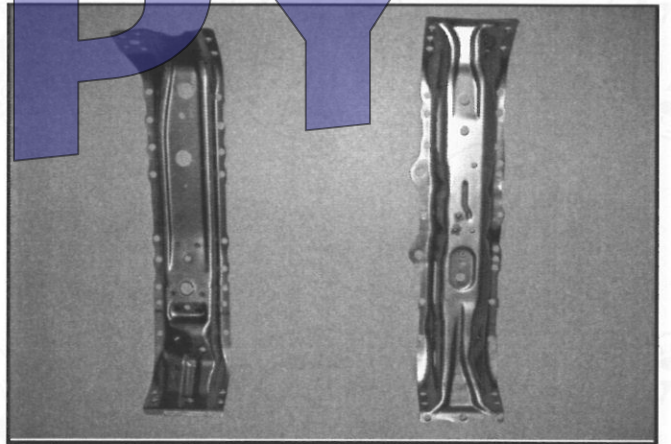
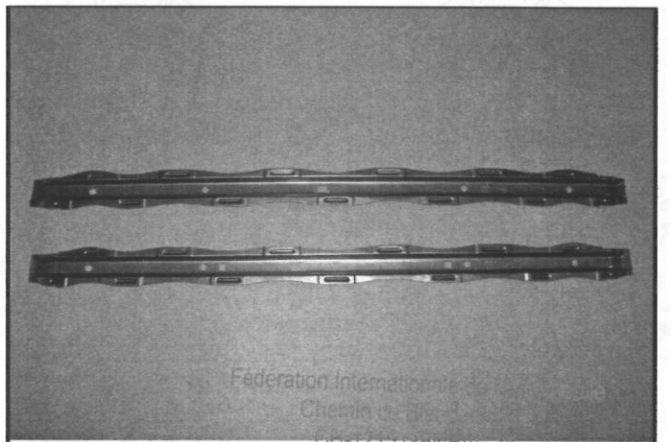

PHOTO N° 0902317\_1



PHOTO N° 0902317\_2



Federation Internationale  
Chemin de la  
DIPLOME 18

Tél.: 41 22 544 44 00  
Fax Sport: 41 22 544 44 50

Marque  
Make  
会社名 **FUJI**

Modèle  
Model  
行名 **GRB**

Homologation N°

**N-5714**

Extension N°

**10/05 ER**

JAF公認番号

**FN-085 ER-11/5**

PHOTO N° 0902318\_1

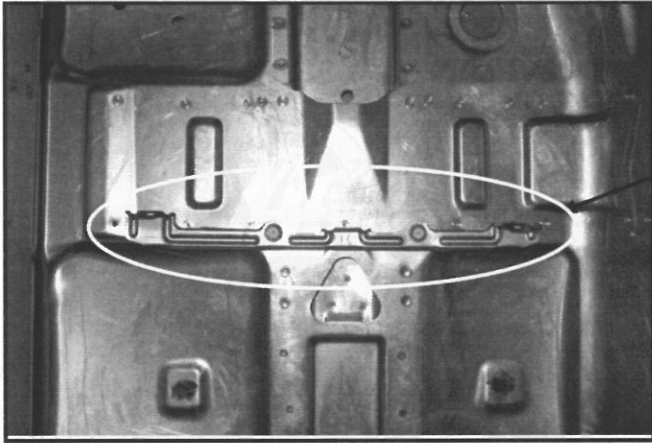

PHOTO N° 0902318\_3

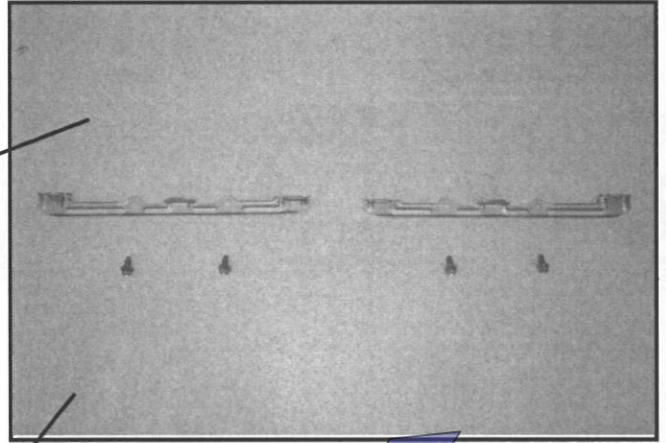

PHOTO N° 0902318\_2

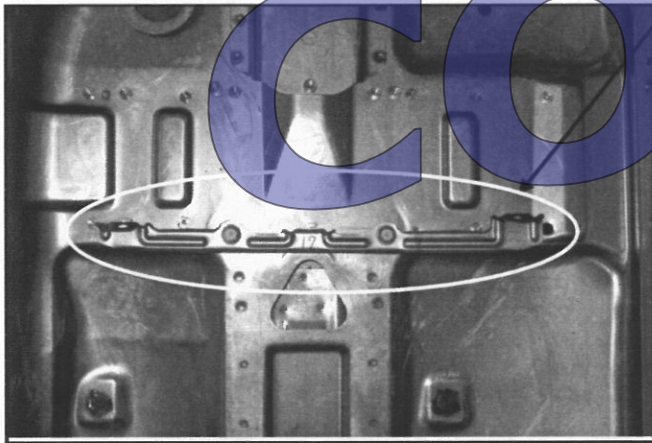

PHOTO N°

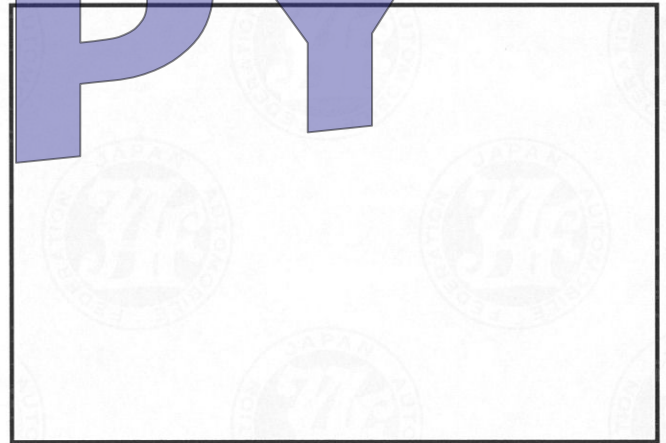

PHOTO N° 0902319\_1

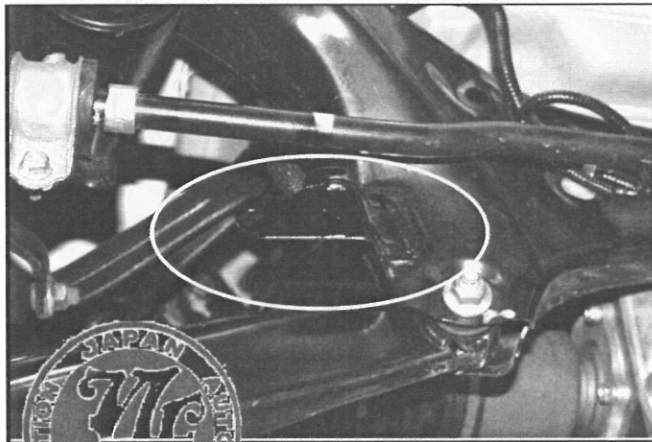
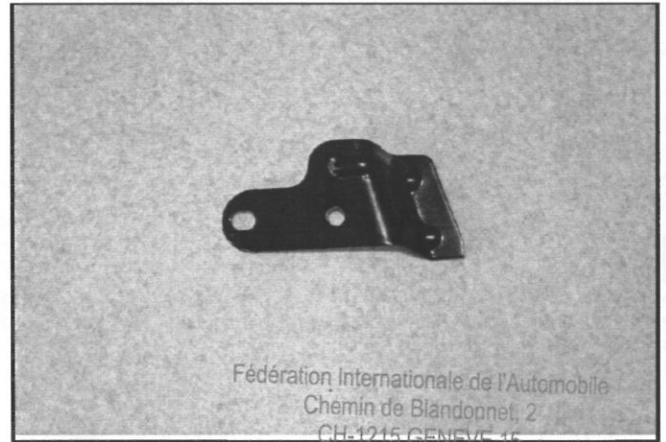

PHOTO N° 0902319\_2



Fédération Internationale de l'Automobile  
Chemin de Blandonnet, 2  
CH-1215 GENEVE 15  
Tél.: 41 22 544 44 00  
Fax Sport: 41 22 544 44 50



Marque  
Make  
会社名 **FUJI**

Modèle  
Model  
型名 **GRB**

Homologation N°

**N-5714**

Extension N°

**10/05 ER**

JAF公認番号

**FN-085 ER-11/5**

PHOTO N° 0902320\_1

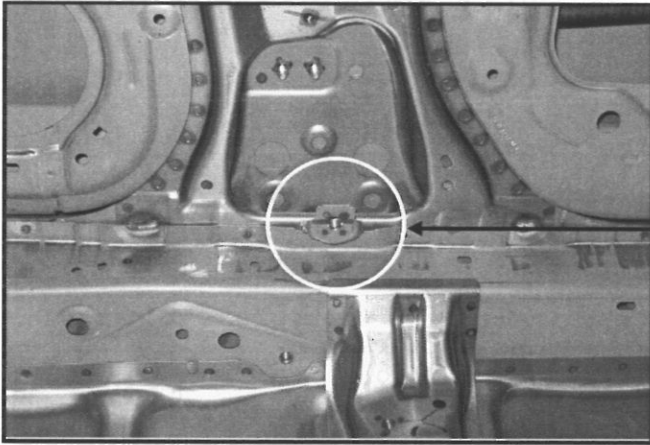

PHOTO N° 0902320\_3

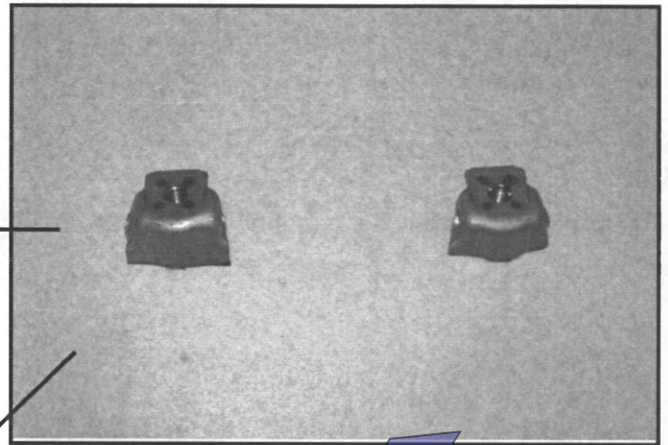

PHOTO N° 0902320\_2

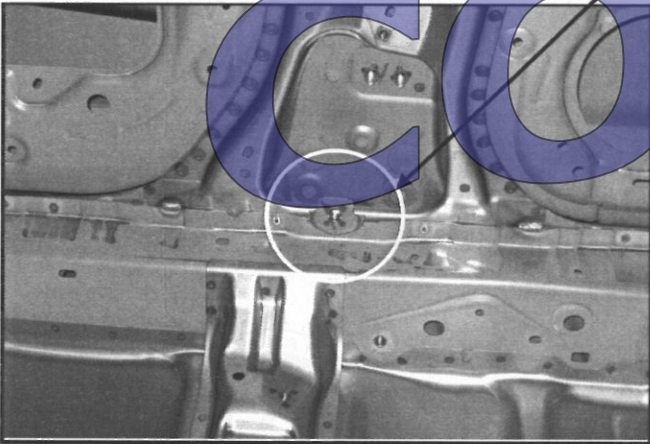

PHOTO N°

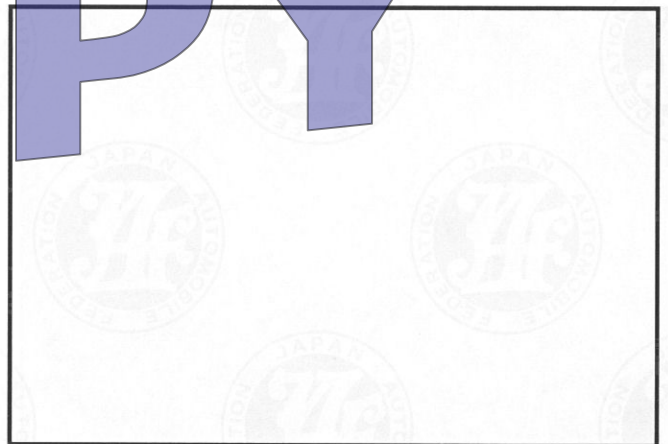

PHOTO N° 0902321\_1



PHOTO N° 0902321\_2



Fédération Internationale de l'Automobile  
Chemin du Pigeonnier  
CHATELAINVILLE 16  
Tél.: 41 22 544 44 00  
Fax Sport: 41 22 544 44 50

Marque  
Make  
会社名 **FUJI**

Modèle  
Model  
行名 **GRB**

Homologation N°

**N-5714**

Extension N°

**10/05 ER**

JAF公認番号

**FN-085 ER-11/5**

PHOTO N° 0902322\_1



PHOTO N° 0902322\_3

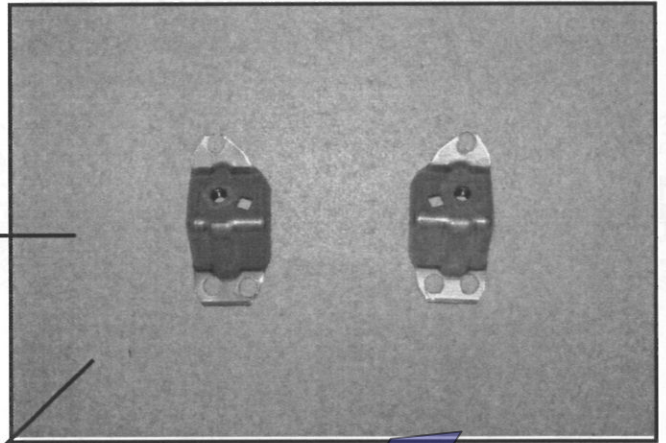

PHOTO N° 0902322\_2

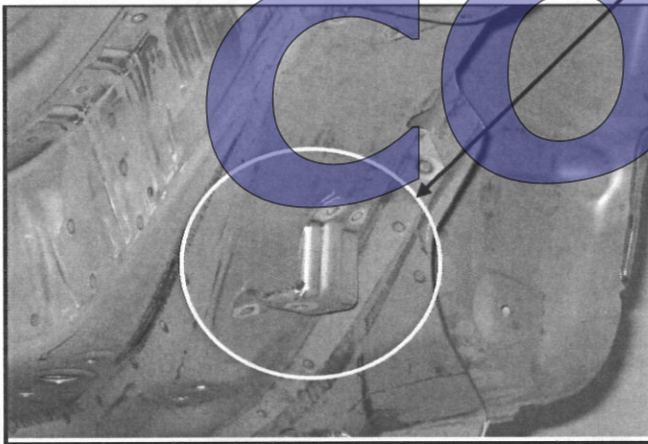

PHOTO N°

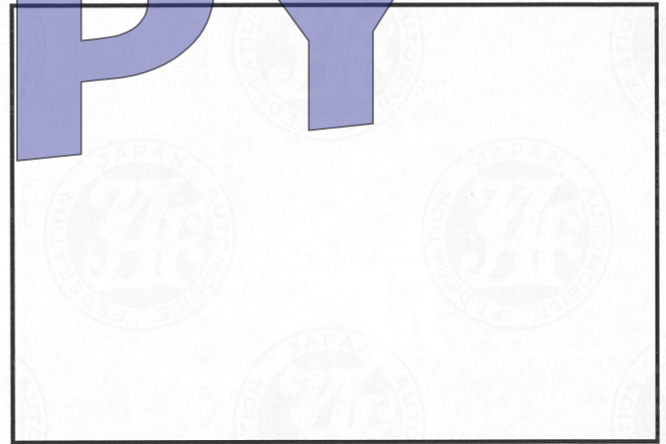

PHOTO N° 0902323\_1

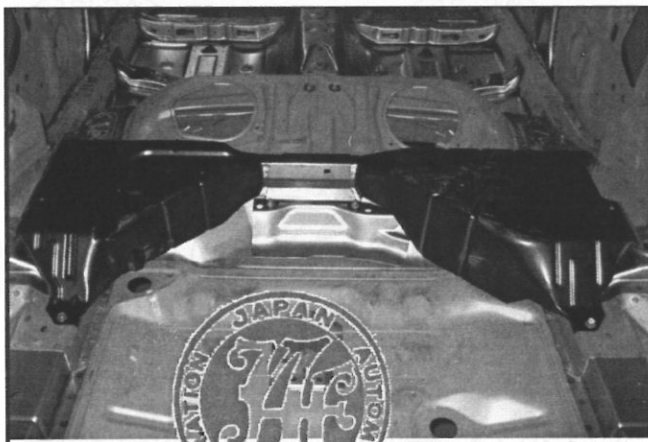
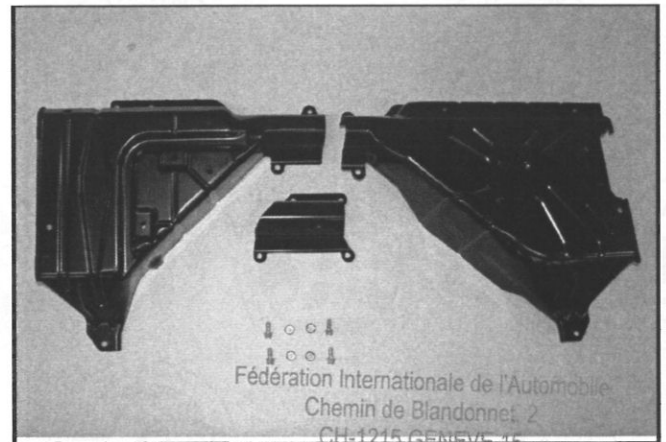

PHOTO N° 0902323\_2



Fédération Internationale de l'Automobile  
Chemin de Blandonnet, 2  
CH-1215 GENEVE 15  
Tél.: 41 22 544 44 00  
Fax Sport: 41 22 544 44 50

Marque  
Make  
会社名 **FUJI**

Modèle  
Model  
行名 **GRB**

Homologation N°

**N-5714**

Extension N°

**10/05 ER**

JAF公認番号

**FN-085 ER-11/5**

PHOTO N° 0902324\_1

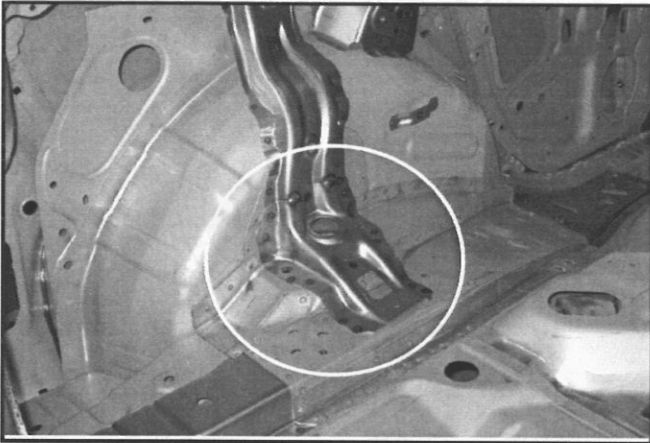

PHOTO N° 0902324\_2

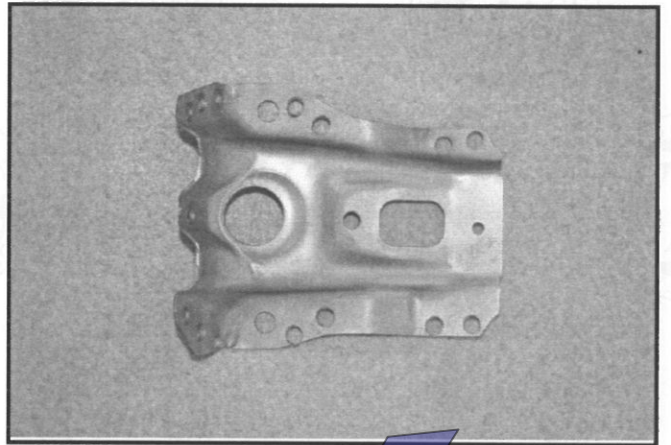

PHOTO N° 0902325\_1



PHOTO N° 0902325\_2

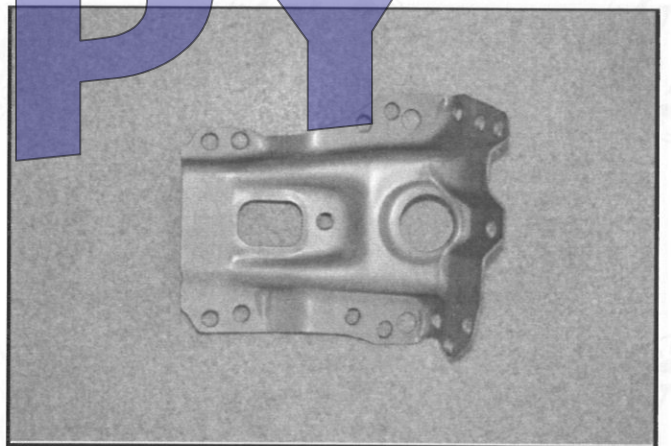

PHOTO N° 0902326\_1

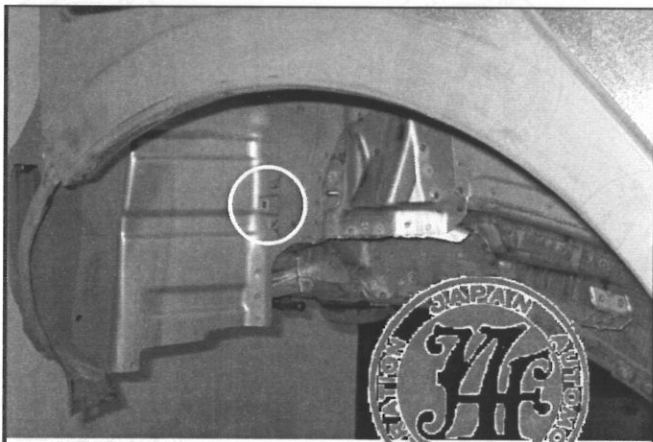
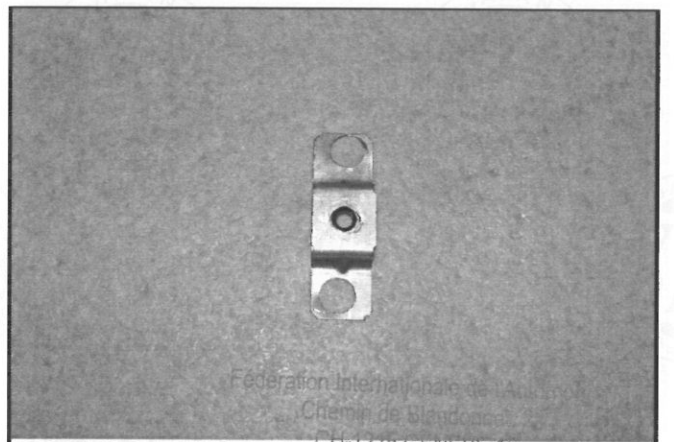

PHOTO N° 0902326\_2



Fédération Internationale de l'Automobile  
Chemin de Blandouze  
CHATELAIN GEMME 46

Tél.: 41 22 544 44 00  
Fax Sport: 41 22 544 44 50

Marque  
Make  
会社名 **FUJI**

Modèle  
Model  
行名 **GRB**

Homologation N°

**N-5714**

Extension N°

**10/05 ER**

JAF公認番号

**FN-085 ER-11/5**

PHOTO N° 0902327\_1



PHOTO N° 0902327\_2

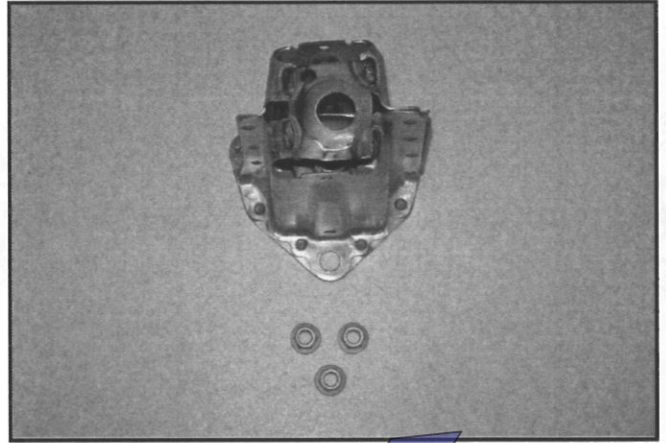

PHOTO N° 0902328\_1

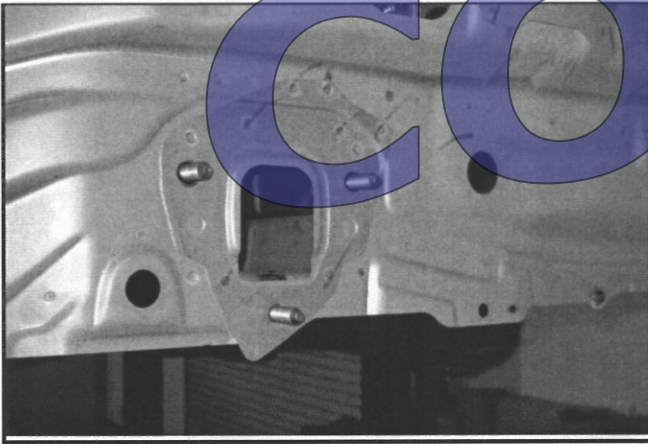

PHOTO N° 0902328\_2

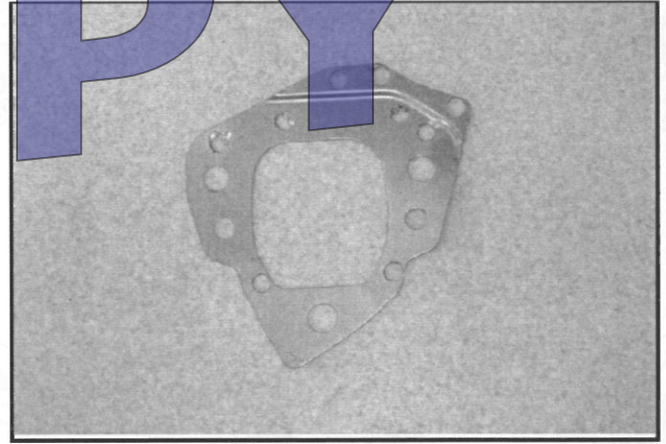

PHOTO N° 0902329\_1

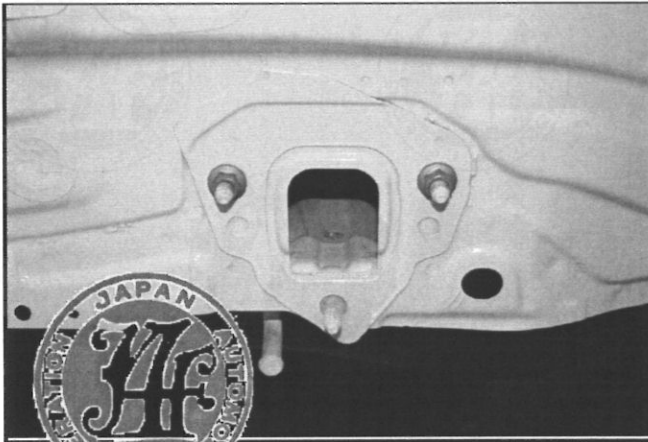

PHOTO N° 0902329\_2



Fédération Internationale de l'Automobile  
Chemin de Blandonnet, 2  
CH-1215 GENEVE 15  
Tél.: 41 22 544 44 00  
Fax Sport: 41 22 544 44 50

Marque  
Make  
会社名 **FUJI**

Modèle  
Model  
行名 **GRB**

Homologation N°

**N-5714**

Extension N°

**10/05 ER**

JAF公認番号

**FN-085 ER-11/5**

PHOTO N° 0902330\_1

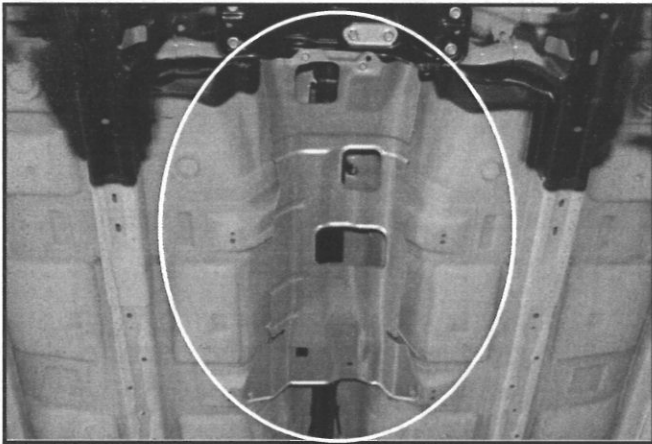

PHOTO N° 0902330\_2

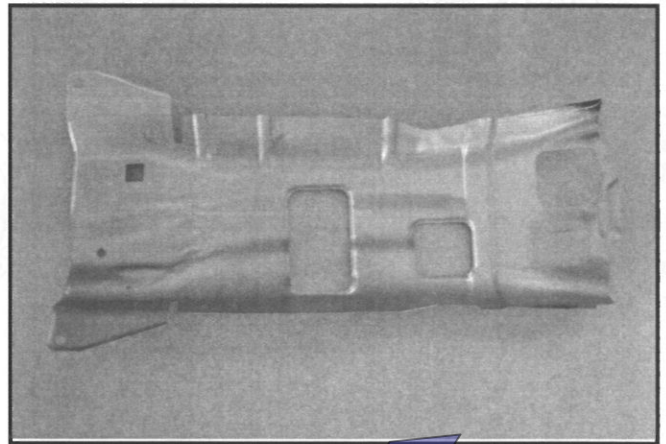

PHOTO N° 0902331\_1

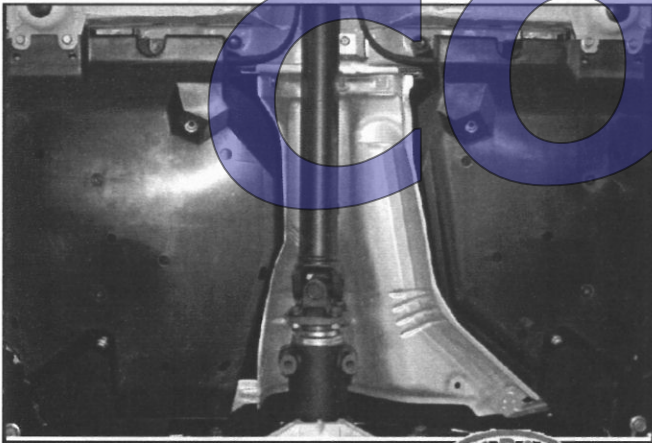

PHOTO N° 0902331\_2

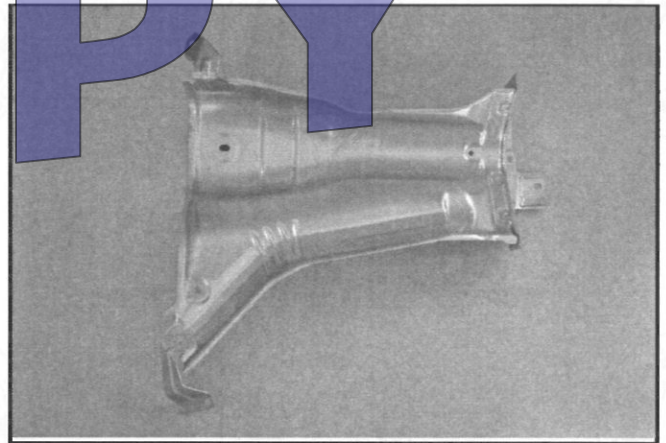

PHOTO N° 0902332\_1

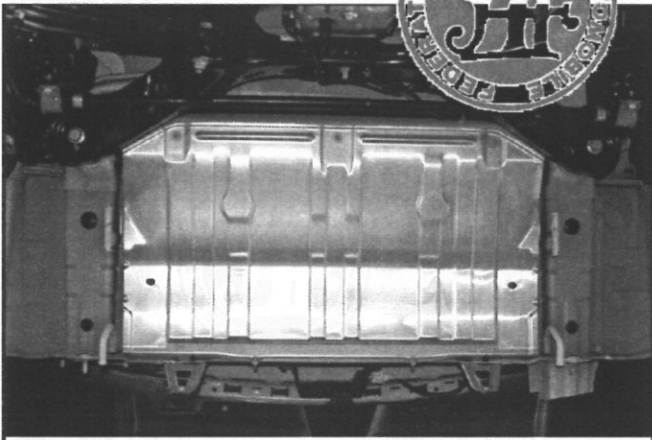
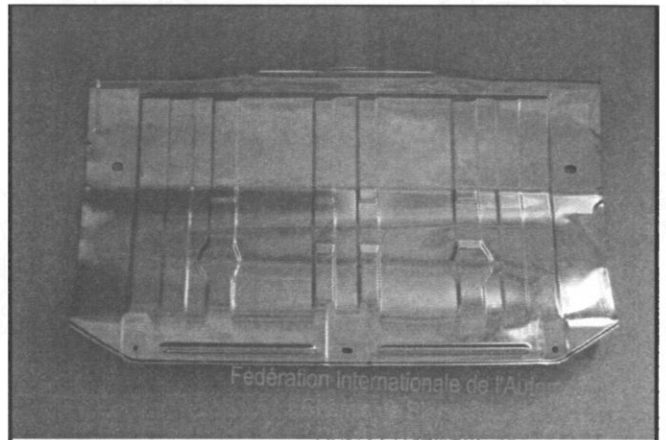

PHOTO N° 0902332\_2



Fédération internationale de l'Automobile  
Tél.: 41 22 544 44 00  
Fax Sport: 41 22 544 44 50