



FEDERATION INTERNATIONALE  
DE L'AUTOMOBILE  
JAPAN AUTO MOBILE FEDERATION  
社団法人 日本自動車連盟

Homologation N°

**N-5714**

Extension N°

**01/01 VO**

Groupe  
Group  
グループ **N**

**NON VALABLE EN SUPER PRODUCTION**  
**NOT VALID IN SUPER PRODUCTION**

JAF公認番号 **FN-085 VO-1/1**

JAF発効日 **2008年1月1日**

FICHE D'EXTENSION D'HOMOLOGATION  
HOMOLOGATION EXTENSION FORM

追加公認書式

- |                          |           |   |                                     |           |  |
|--------------------------|-----------|---|-------------------------------------|-----------|--|
| <input type="checkbox"/> | <b>ES</b> | Evolution sportive du type / Sporting evolution of the type<br>スポーツ進化 | <input checked="" type="checkbox"/> | <b>VO</b> | Variante option / Option variant<br>オプション変型              |
| <input type="checkbox"/> | <b>ET</b> | Evolution normale du type / Normal evolution of the type<br>型式の正常進化   | <input type="checkbox"/>            | <b>VP</b> | Variante de Production / Production variant<br>プロダクション変型 |
| <input type="checkbox"/> | <b>VF</b> | Variante de fourniture / Supply variant<br>供給変型                       | <input type="checkbox"/>            | <b>ER</b> | Erratum / Erratum<br>誤記訂正                                |

Véhicule : Constructeur

Vehicle : Manufacturer **FUJI HEAVY INDUSTRIES LTD.**

車両 : 製造会社名

Modèle et type

Model and type **SUBARU IMPREZA WRX STI (2007) , GRB**

モデルと型式

Homologation valable à partir du

Homologation valid as from

FIA公認発効年月日

**01 JAN 2008**



Page or ext. 頁または追加番号	Article 項目	Description 記述
	331	<p><b>ENGINE SUPPORT</b></p> <p>Photo 0711401) Engine supports and brackets dismantled Drawings 0711971) Engine support dimensions when dismantled Position of the engine is identical to the original</p> <p><b>SECONDARY AIR SYSTEM</b></p> <p>Following parts are removable Photo 0711402) Secondary air valve and brackets, dismantled Photo 0711403) Tube Lh side, dismantled Photo 0711404) Combination valve and tube RH side, dismantled Photo 0711405) Additional parts for the engine, when removing Photo 0711402 , 0711403, 0711404 No modifications will be made on the cylinder head when removing secondary air system except the parts shown on photo 0711405) for closing.</p> <p><b>COOLING SYSTEM</b></p> <p>Photo 0711406) Radiator hose kit "Part number 45162ZR000" Photo 0711407) Radiator kit, dismantled "Part number 45119FE020" Photo 0711408) Radiator kit, mounted Photo 0711409) Radiator dismantled - included in Photo 0711406 Part from homologation No. A/N-5695/E 15</p>



Fédération Internationale de l'Automobile  
Comité de Blandonnet, 2  
CH-1700 Sion, Suisse  
Tel.: +41 22 544 44 00  
Fax Sport +41 22 544 44 50

Marque  
Make  
会社名 **FUJI**

Modèle  
Model  
モデル **GRB**

Homologation N°

**N-5714**

Extension N°

**01/01 VO**

JAF公認番号

**FN-085 VO-1/1**

Page or ext. 頁または追加番号	Article 項目	Description 記述																					
	331	<p><b>COOLING SYSTEM</b></p> <p>Photo 0711410) Engine oil cooler kit, dismantled "Part number 45511ZR000" Photo 0711411) Engine oil cooler kit, mounted</p> <p><b>RESTRICTOR</b></p> <p>Photo 0711412) Restrictor &amp; duct assembly, type 1N Photo 0711413) Disassembled parts, type 1N Elbow turbo charger : Part number "14459ZR000" Restrictor : Part number "10020ZR000"</p> <p>Photo 0711414) Restrictor &amp; duct assembly, type 2N Photo 0711415) Disassembled parts, type 2N Elbow turbo charger : Part number "G2/J2/009" Restrictor : Part number "N14/J2/001"</p> <p>Photo 0711416) Modification of intake manifold for Photo 0711414, 0711415 Photo 0711417) Modification of intake manifold adaptor for Photo 0711414, 0711415</p>																					
	602	<p><b>CLUTCH</b></p> <p>Photo 0711418) Clutch cover outside view Photo 0711419) Clutch cover inside view</p>																					
	603	<p><b>GEAR BOX</b></p> <p>d) Type and location of control Photo 0711420) Gear shift link</p> <p>e) Ratios:</p> <table border="1"> <thead> <tr> <th></th> <th>Teeth</th> <th>Ratios</th> </tr> </thead> <tbody> <tr> <td>1</td> <td>40/12</td> <td>3.333</td> </tr> <tr> <td>2</td> <td>31/13</td> <td>2.385</td> </tr> <tr> <td>3</td> <td>28/16</td> <td>1.750</td> </tr> <tr> <td>4</td> <td>24/18</td> <td>1.333</td> </tr> <tr> <td>5</td> <td>26/25</td> <td>1.040</td> </tr> <tr> <td>R</td> <td>(26/12)×(41/26)</td> <td>3.417</td> </tr> </tbody> </table> <p>h) Oil cooler</p> <p>Photo 0711421) Oil cooler kit, dismantled Photo 0711422) Oil cooler kit, mounted Photo 0711423) Gearbox case modification for connecting oil cooler kit Photo 0711424) Gearbox case modification for connecting oil cooler kit Photo 0711425) Gearbox case modification and additional parts Photo 0711426) Gearbox case modification and additional parts</p>		Teeth	Ratios	1	40/12	3.333	2	31/13	2.385	3	28/16	1.750	4	24/18	1.333	5	26/25	1.040	R	(26/12)×(41/26)	3.417
	Teeth	Ratios																					
1	40/12	3.333																					
2	31/13	2.385																					
3	28/16	1.750																					
4	24/18	1.333																					
5	26/25	1.040																					
R	(26/12)×(41/26)	3.417																					



for connecting oil cooler kit  
Fédération Internationale de l'Automobile  
Chemin de Blandonnet, 2  
1190 Gland, Suisse  
for connecting oil cooler kit

Tél.: 41 22 544 44 00  
Fax Sport: 41 22 544 44 50

Marque  
Make  
会社名 **FUJI**

Modèle  
Model  
モデル **GRB**

Homologation N°

**N-5714**

Extension N°

**01/01 VO**

JAF公認番号

**FN-085 VO-1/1**

Page or ext. 頁または追加番号	Article 項目	Description 記述
	604	TRANSFER  Ratios: 1.000 Teeth: 31/31
	605	FINAL DRIVE  Teeth            Ratios Front    39/11        3.545
	d)	Type of differential limitation Photo 0711427) Front LSD dismounted Photo 0711428) Front LSD disassembled Drawing 0711972) Front LSD cam angle Photo 0711429) Rear LSD dismounted Photo 0711430) Rear LSD disassembled Drawing 0711973) Rear LSD cam angle
	f)	Photo 0711431) Rear differential oil cooler
	606	SHAFTS  Photo 0711432) Front transversal half shafts, type 1NF - Part number "28321ZR000" Drawing 0711974) Front transversal half shafts, type 1NF Photo 0711433) Rear transversal half shafts, type 1NR - Part number "28421ZR000" Drawing 0711975) Rear transversal half shafts, type 1NR
	701	SUSPENSION  Photo 0711434) Front top mount plate, view 1 Photo 0711435) Front top mount plate, view 2 Drawing 0711976) Front top mount plate The position (X,Y,Z) of the series articulation points are identical to the original Photo 0711436) Rear top mount plate, view 1 Photo 0711437) Rear top mount plate, view 2 Drawing 0711977) Front top mount plate The position (X,Y,Z) of the series articulation points are identical to the original Drawing 0711978) Modification for front upright Drawing 0711979) Modification for rear upright
	706	STABILISER  Photo 0711438) Front stabiliser, effective diameter 18 ± 0.4mm : part number "28410ZR000" Photo 0711439) Front stabiliser, effective diameter 21 ± 0.4mm : part number "28410SC100" Photo 0711440) Rear stabiliser, effective diameter 16 ± 0.4mm : part number "20451SC010" Photo 0711441) Rear stabiliser, effective diameter 20 ± 0.4mm : part number "28410ZR200"



Fédération Française des Automobile Techniciens  
Chemin de Blandonnet, 2  
CH-1215, PSEZEL  
Tel.: 41 22 544 44 00  
Fax Sport: 41 22 544 44 50

Marque  
Make  
会社名 **FUJI**

Modèle  
Model  
モデル **GRB**

Homologation N°

**N-5714**

Extension N°

**01/01 VO**

JAF公認番号

**FN-085 VO-1/1**

Page or ext. 頁または追加番号	Article 項目	Description 記述
	803	<b>BRAKES</b>
	c)	<b>Brake servo</b>  Photo 0711442) Master cylinder spacer and push rod assembled, dismantled Master cylinder spacer : Part number "26402ZR000" Push rod for right hand drive car : Part number "26402ZR010" only use with "26402ZR000" Push rod for left hand drive car : Part number "26402ZR020" only use with "26402ZR000" DRAWING 0711980) Master cylinder spacer  Photo 0711443) Braking regulator dismantled DRAWING 0711981) Braking regulator system, when using standard hand brake system DRAWING 0711982) Braking regulator with hydraulic parking brake system
	h) h1)	<b>Parking brake</b> Control system : Hydraulic Optional with original cables as a standard  Photo 0711444) Parking brake, dismantled, type-1, right hand side Photo 0711445) Parking brake, mounted, type-1, right hand side Photo 0711446) Parking brake, dismantled, type-1, left hand side Photo 0711447) Parking brake, mounted, type-1, left hand side Photo 0711448) Parking brake, dismantled, type-2 Photo 0711449) Parking brake, mounted, type-2 Drawing 0711983) Hydraulic parking brake control system  <b>Racing brake parts</b>  Photo 0711450) Front caliper, 1NF Photo 0711451) Front disc, type 1NF-T Photo 0711452) Front brake kit, type 1NF-T Photo 0711453) Front disc, type 2NF-G Photo 0711454) Front brake kit, type 2NF-G Photo 0711455) Front guard Photo 0711456) Rear caliper, 1NR Photo 0711457) Rear disc, type 1NR Photo 0711458) Rear brake kit, type 1NR Photo 0711459) Rear brake kit, type 2NR Photo 0711460) Rear guard
	804	<b>STEERING</b>  Photo 0711461) Oil cooler



Fédération Internationale de l'Automobile  
Chemin de Blandonnet, 2  
CH-1215 GENEVE 15  
Tél.: 41 22 544 44 00  
Fax Sport: 41 22 544 44 50



Marque  
Make  
会社名 **FUJI**

Modèle  
Model  
モデル **GRB**

Homologation N°

**N-5714**

Extension N°

**01/01 VO**

JAF公認番号

**FN-085 VO-1/1**

Page or ext. 頁または追加番号	Article 項目	Description 記述
	901	<b>INTERIOR</b>  Photo 0711462) Seat mounting bracket, Left hand drive - Left hand side Photo 0711463) Seat mounting bracket, Left hand drive - Right hand side Photo 0711464) Seat mounting tube, Right hand drive - Left hand side Tube diameter : 38mm / Tube thickness : 1.2mm Tube diameter : 38mm / Tube thickness : 2.0mm Photo 0711465) Seat mounting tube, Right hand drive - Right hand side Tube diameter : 38mm / Tube thickness : 1.2mm Tube diameter : 38mm / Tube thickness : 2.0mm Photo 0711466) Seat mounting tube, Left hand drive - Left hand side Tube diameter : 38mm / Tube thickness : 1.2mm Tube diameter : 38mm / Tube thickness : 2.0mm Tube diameter : 40mm / Tube thickness : 2.0mm Photo 0711467) Seat mounting tube, Left hand drive - Right hand side Tube diameter : 38mm / Tube thickness : 1.2mm Tube diameter : 38mm / Tube thickness : 2.0mm Tube diameter : 40mm / Tube thickness : 2.0mm Photo 0711468) Central console, dismounted Photo 0711469) Central console, mounted May be modified when mounting Photo 0711444, 0711445, 0711446, 0711447, 0711448, 0711449
	902	<b>EXTERIOR</b>  Photo 0711470) Roof ventilator Drawing 0711984) Roof ventilator



Fédération Internationale de l'Automobile  
Chemin de Blandonnet, 2  
CH-1215 GENEVE 15  
Tél.: 41 22 544 44 00  
Fax Sport: 41 22 544 44 50

Marque  
Make  
会社名 **FUJI**

Modèle  
Model  
モデル **GRB**

Homologation N°

**N-5714**

Extension N°

**01/01 VO**

JAF公認番号

**FN-085 VO-1/1**

PHOTO N° 0711401

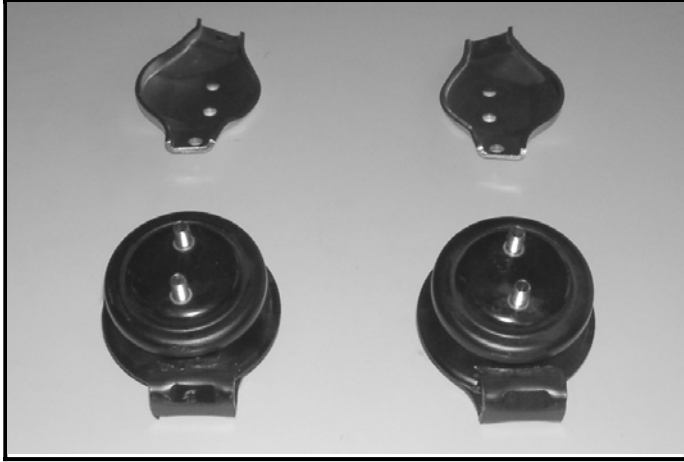

PHOTO N° 0711402



PHOTO N° 0711403



PHOTO N° 0711404



PHOTO N° 0711405

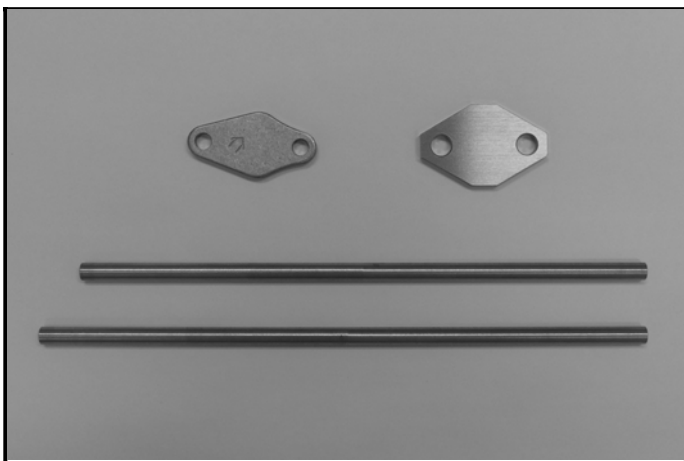

PHOTO N° 0711406



Fédération Internationale de l'Automobile  
Chemin de Blattenet, 2  
CH-1215 GENEVE 15  
Tel.: 41 22 544 44 00  
Fax Sport: 41 22 544 44 50

Marque  
Make  
会社名 **FUJI**

Modèle  
Model  
モデル **GRB**

Homologation N°

**N-5714**

Extension N°

**01/01 VO**

JAF公認番号

**FN-085 VO-1/1**

PHOTO N° 0711407

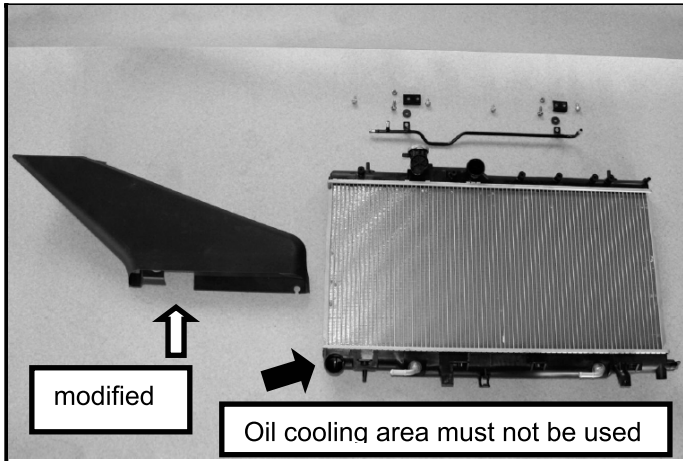

PHOTO N° 0711408

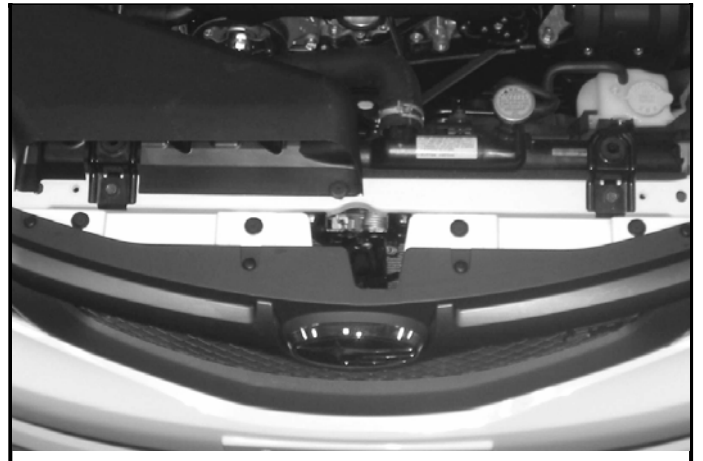

PHOTO N° 0711409

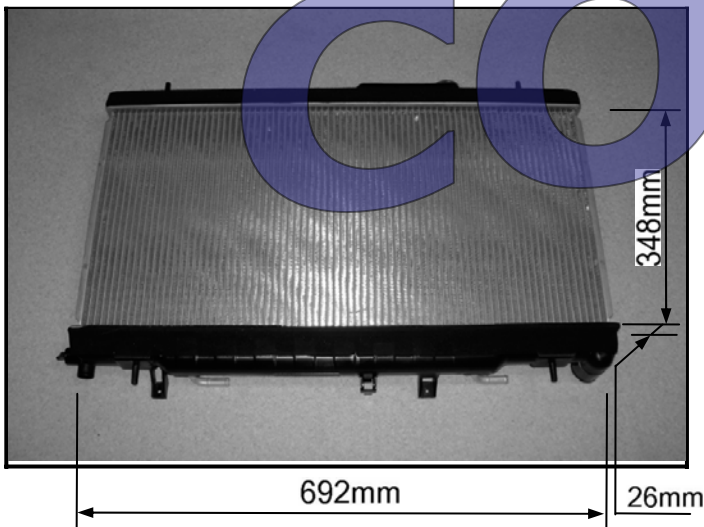

PHOTO N° 0711410

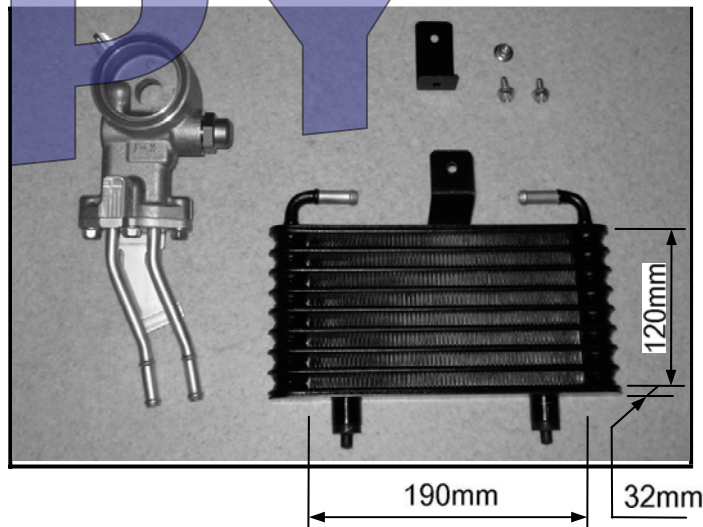

PHOTO N° 0711411

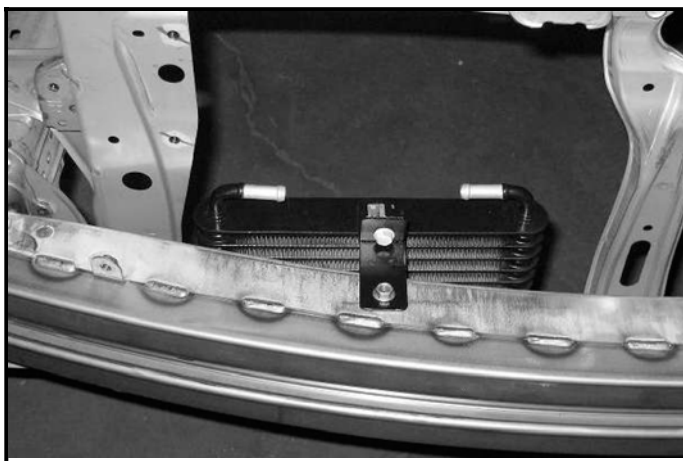

PHOTO N° 0711412





Marque  
Make  
会社名 **FUJI**

Modèle  
Model  
モデル **GRB**

Homologation N°

**N-5714**

Extension N°

**01/01 VO**

JAF公認番号

**FN-085 VO-1/1**

PHOTO N° 0711413

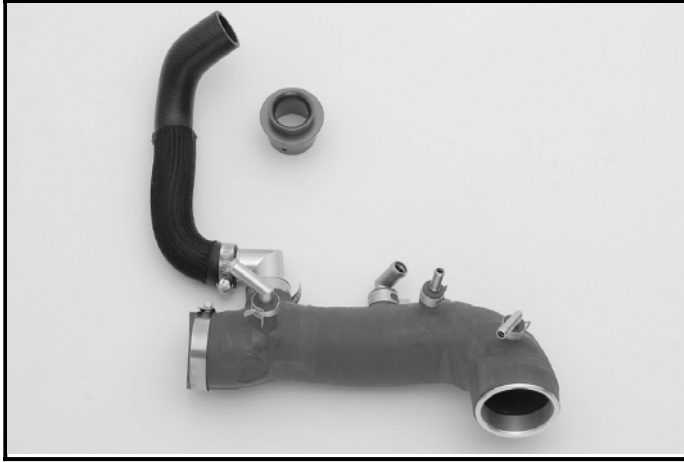

PHOTO N° 0711414

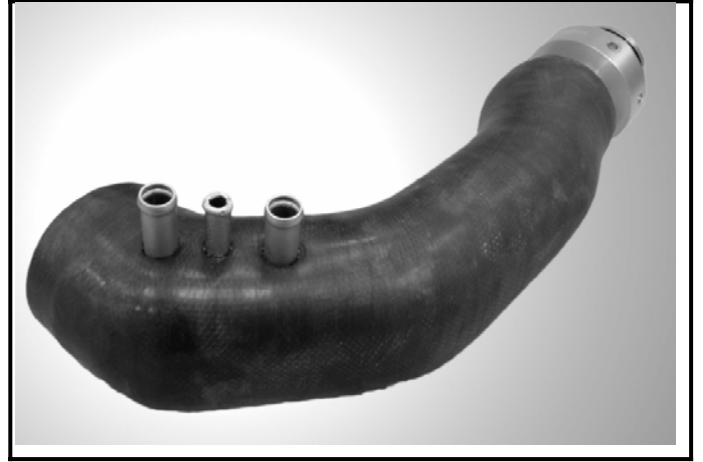

PHOTO N° 0711415

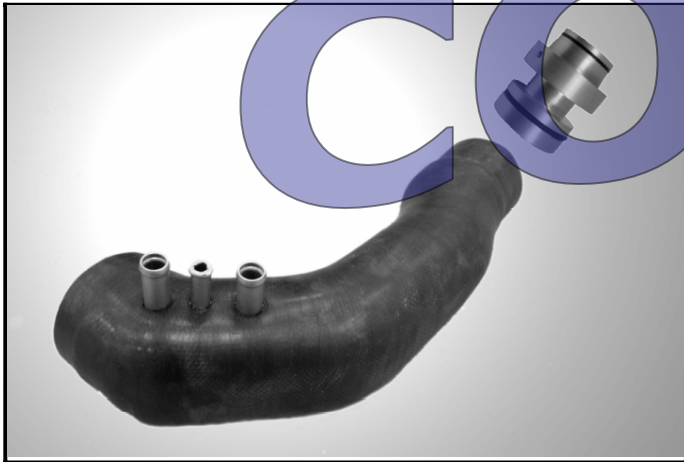

PHOTO N° 0711416

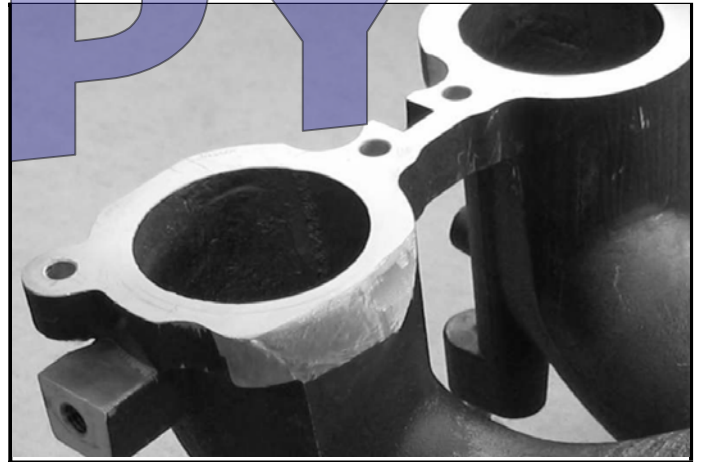

PHOTO N° 0711417

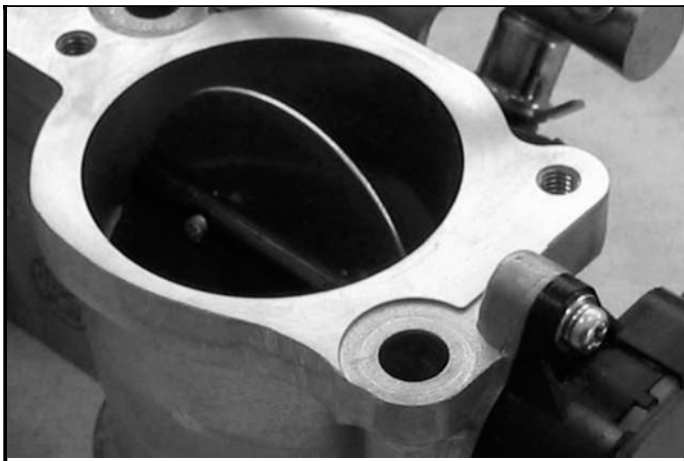

PHOTO N° 0711418



Transmission / Accessoire / Automobile  
Chemin de la Glacière, 2  
CH-1214 GENEVE 15  
Tel.: 41 22 544 44 00  
Fax Sport: 41 22 544 44 50

Marque  
Make  
会社名 **FUJI**

Modèle  
Model  
モデル **GRB**

Homologation N°

**N-5714**

Extension N°

**01/01 VO**

JAF公認番号

**FN-085 VO-1/1**

PHOTO N° 0711419

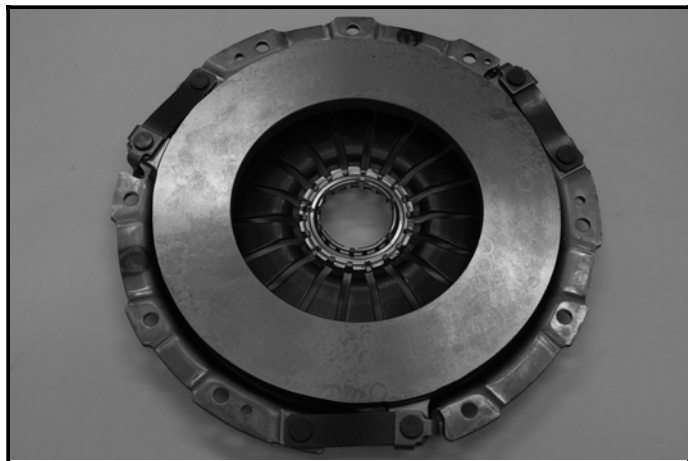

PHOTO N° 0711420

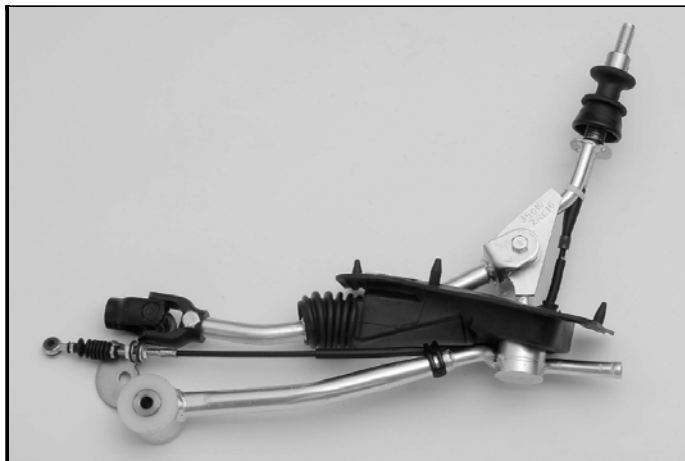

PHOTO N° 0711421

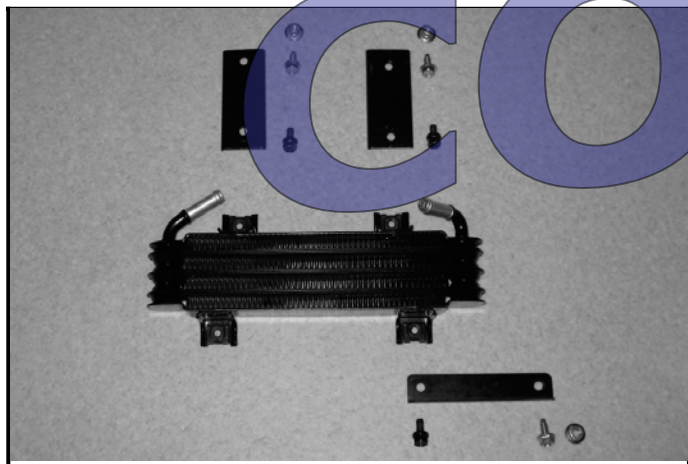

PHOTO N° 0711422

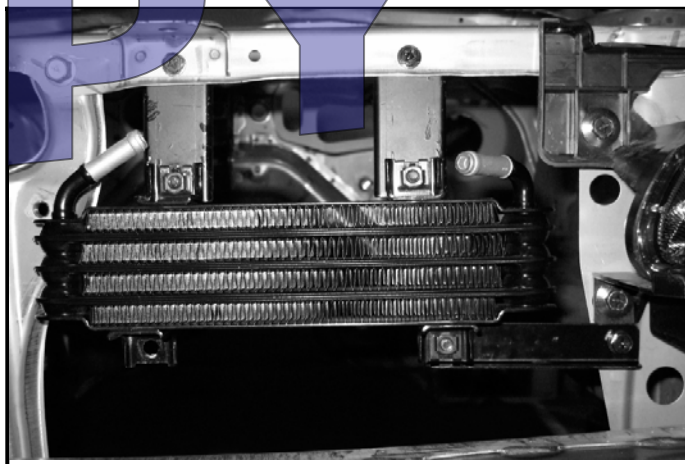

PHOTO N° 0711423

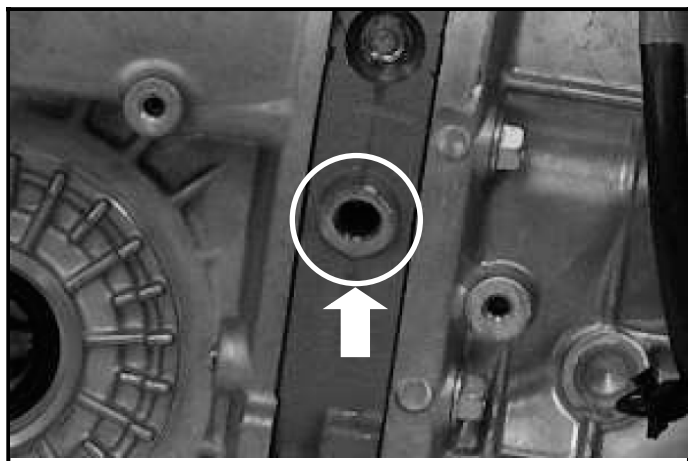
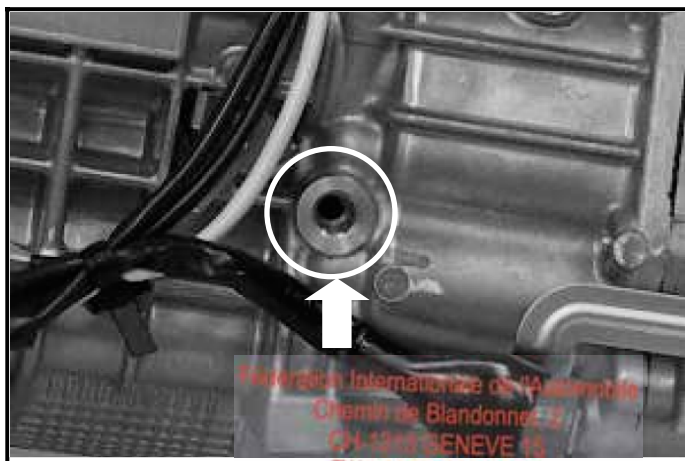

PHOTO N° 0711424



Fédération Internationale de l'Automobile  
Chemin de Blandonnet 2  
CH-1211 GENEVE 15  
Tel.: 41 22 544 44 00  
Fax Sport: 41 22 544 44 50

Marque  
Make  
会社名 **FUJI**

Modèle  
Model  
モデル **GRB**

Homologation N°

**N-5714**

Extension N°

**01/01 VO**

JAF公認番号

**FN-085 VO-1/1**

PHOTO N° 0711425

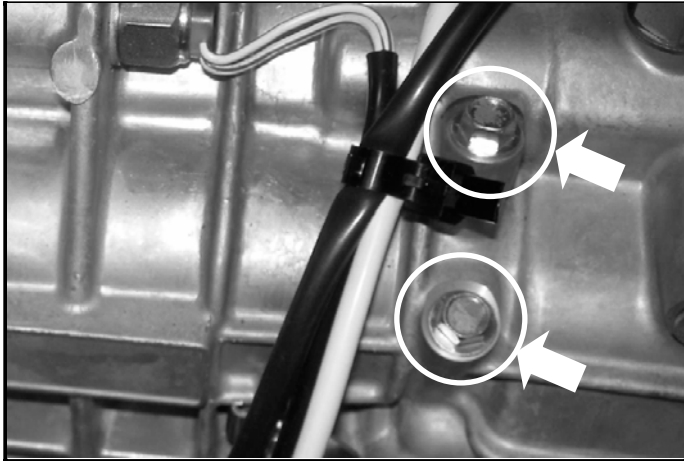

PHOTO N° 0711426

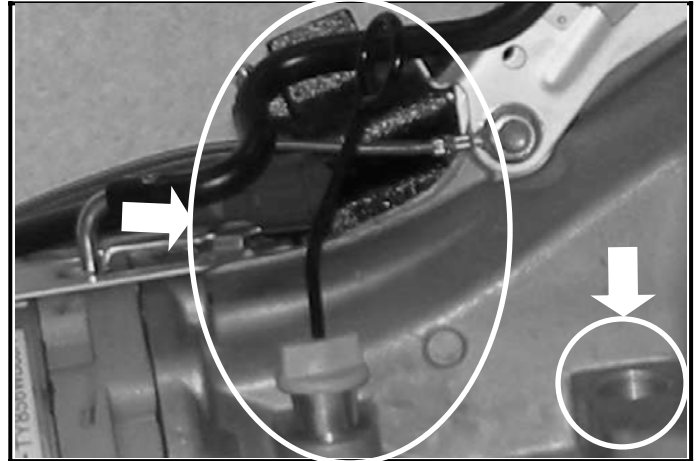

PHOTO N° 0711427

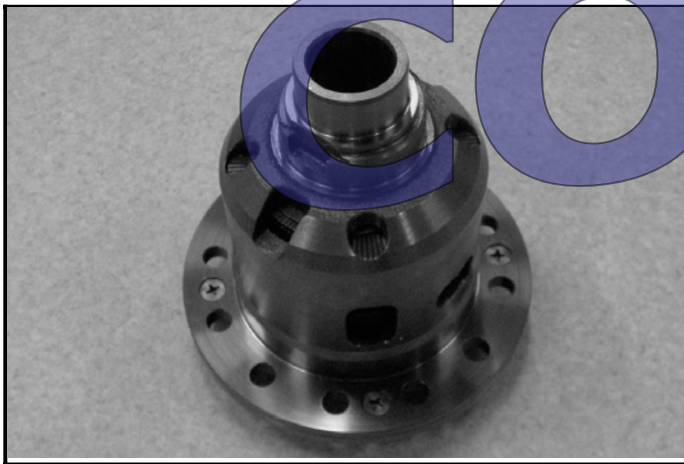

PHOTO N° 0711428

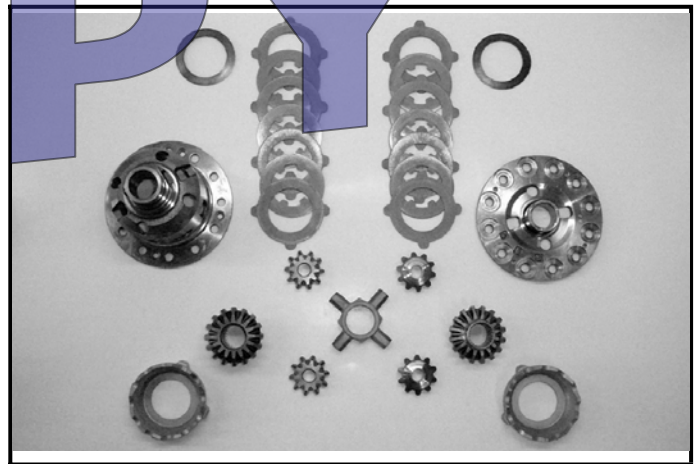

PHOTO N° 0711429



PHOTO N° 0711430



Fédération Internationale de l'Automobile  
Chemin de Blandonnet, 2  
CH-1215 GENEVE 15  
Tel.: 41 22 544 44 00  
Fax Sport: 41 22 544 44 50



Marque  
Make  
会社名 **FUJI**

Modèle  
Model  
モデル **GRB**

Homologation N°

**N-5714**

Extension N°

**01/01 VO**

JAF公認番号

**FN-085 VO-1/1**

PHOTO N° 0711431

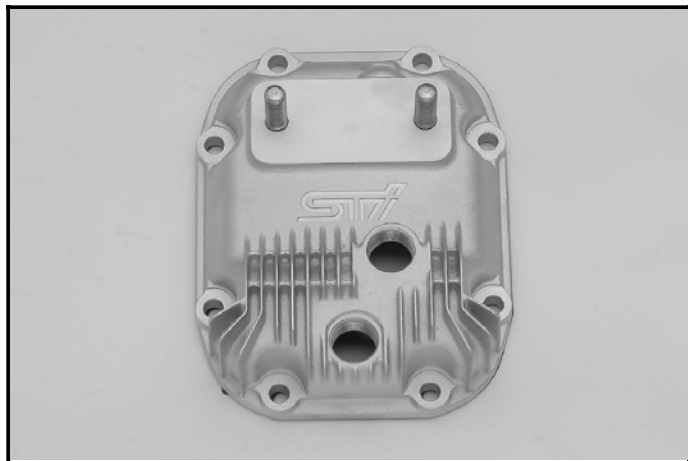

PHOTO N° 0711432



PHOTO N° 0711433

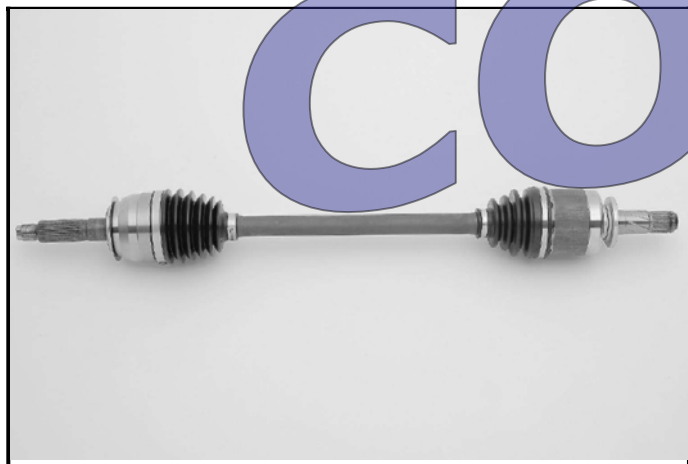

PHOTO N° 0711434

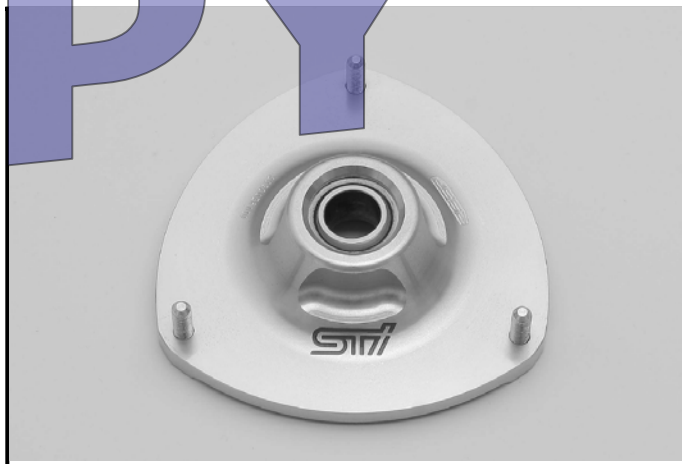

PHOTO N° 0711435



PHOTO N° 0711436



Fédération Internationale de l'Automobile  
Chemin de Blandonnet, 2  
CH-1215 GENEVE 15  
Tel.: 41 22 544 44 00  
Fax Sport: 41 22 544 44 50

Marque  
Make  
会社名 **FUJI**

Modèle  
Model  
モデル **GRB**

Homologation N°

**N-5714**

Extension N°

**01/01 VO**

JAF公認番号

**FN-085 VO-1/1**

PHOTO N° 0711437



PHOTO N° 0711438

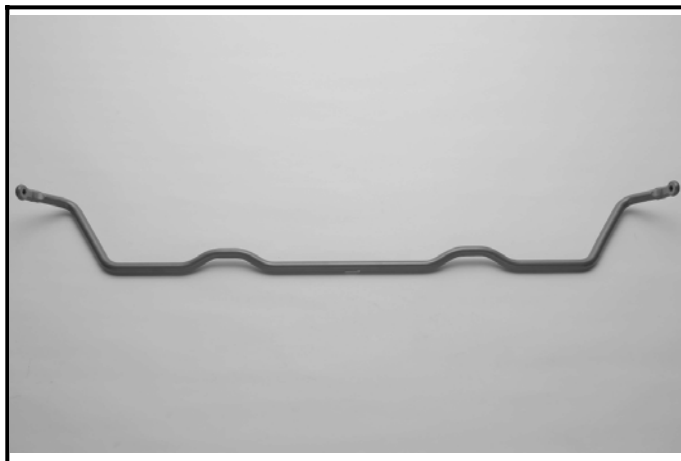

PHOTO N° 0711439

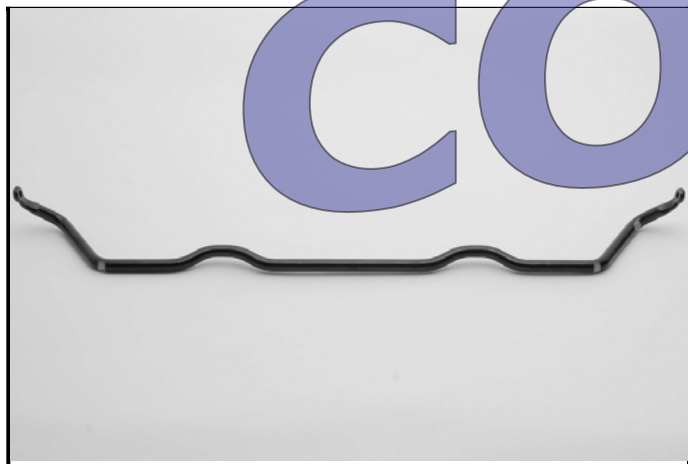

PHOTO N° 0711440

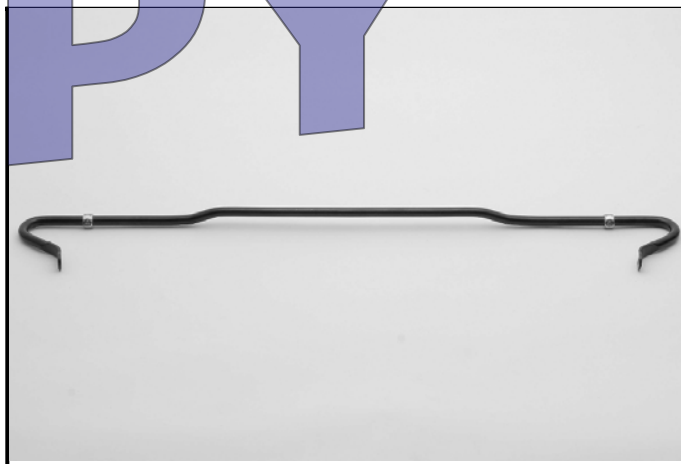

PHOTO N° 0711441



PHOTO N° 0711442



Fédération Internationale de l'Automobile  
Chemin de Blandonnet, 2  
CH-1215 GENEVE 15  
Tél.: 41 22 544 44 00  
Fax Sport: 41 22 544 44 50

Marque  
Make  
会社名 **FUJI**

Modèle  
Model  
モデル **GRB**

Homologation N°

**N-5714**

Extension N°

**01/01 VO**

JAF公認番号

**FN-085 VO-1/1**

PHOTO N° 0711443

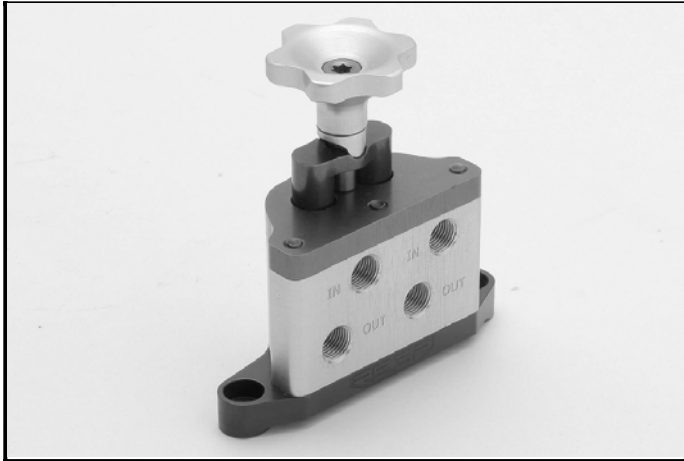

PHOTO N° 0711444

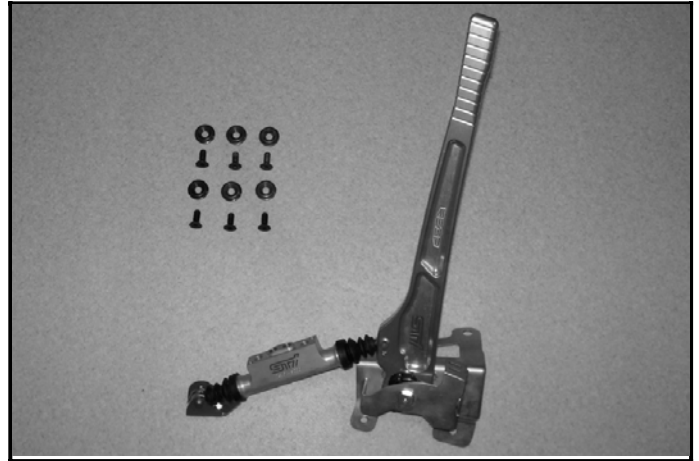

PHOTO N° 0711445

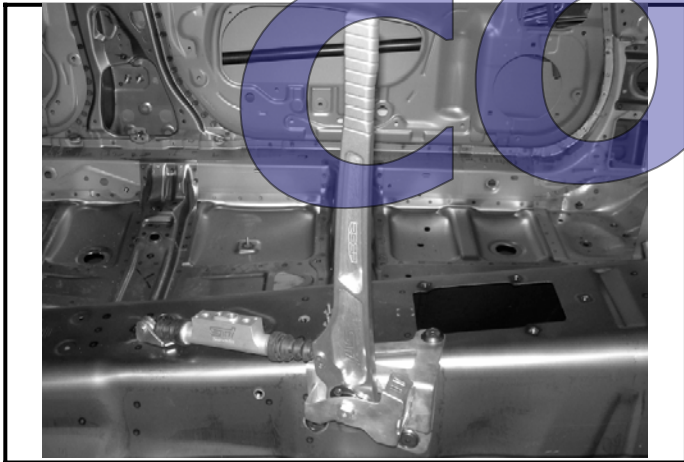

PHOTO N° 0711446

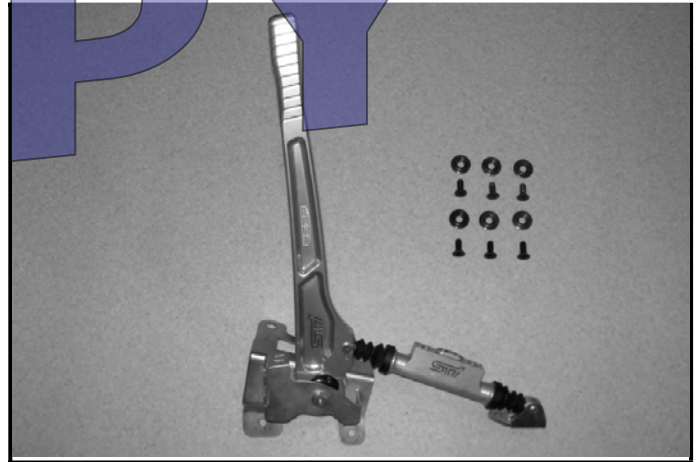

PHOTO N° 0711447

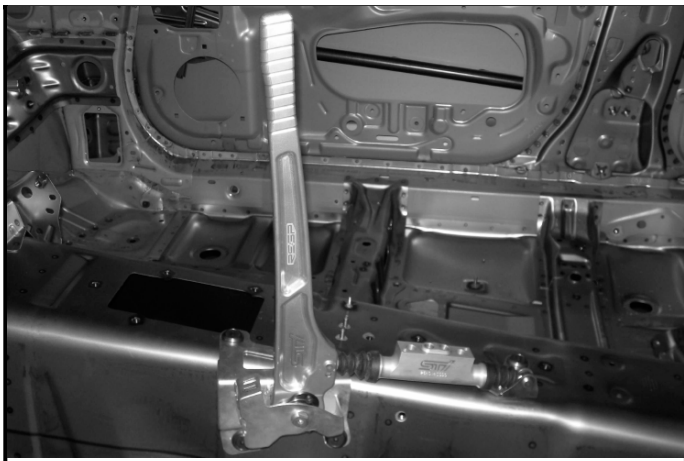

PHOTO N° 0711448



Fédération Internationale de l'Automobile  
Chemin de Flandrennet, 2  
CH-1215 GENEVE 15  
Tel.: 41 22 544 44 00  
Fax Sport: 41 22 544 44 50



Marque  
Make  
会社名 **FUJI**

Modèle  
Model  
モデル **GRB**

Homologation N°

**N-5714**

Extension N°

**01/01 VO**

JAF公認番号

**FN-085 VO-1/1**

PHOTO N° 0711449

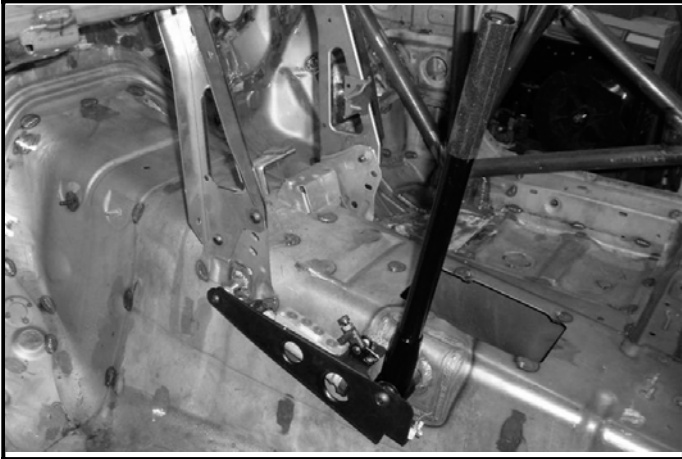

PHOTO N° 0711452



PHOTO N° 0711454

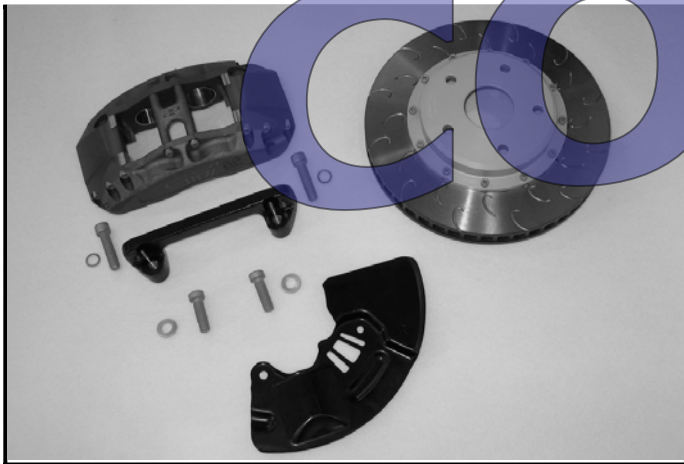

PHOTO N° 0711455



PHOTO N° 0711458

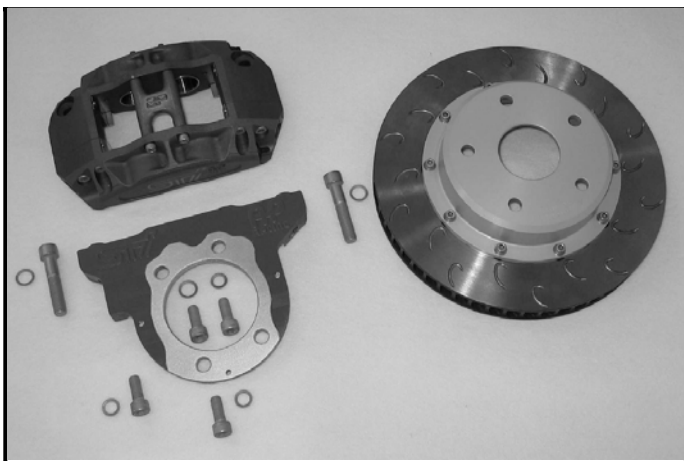

PHOTO N° 0711459



Fédération Internationale de l'Automobile  
Chemin de Blandonnet, 2  
CH-1215 GENEVE 15  
Tel.: 41 22 544 44 00  
Fax Sport: 41 22 544 44 50

Marque  
Make  
会社名 **FUJI**

Modèle  
Model  
モデル **GRB**

Homologation N°

**N-5714**

Extension N°

**01/01 VO**

JAF公認番号

**FN-085 VO-1/1**

PHOTO N° 0711460

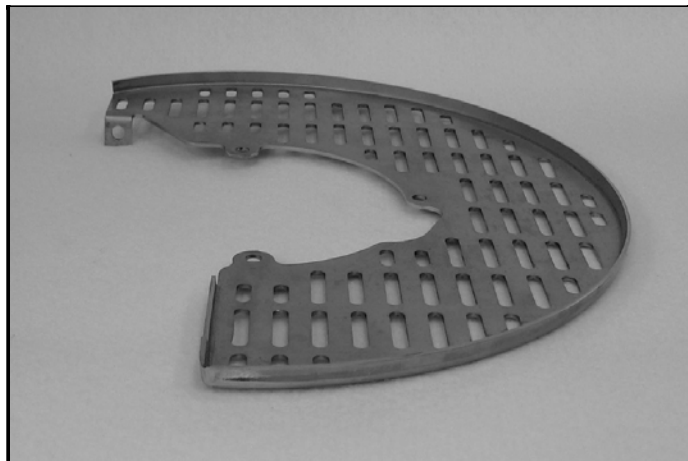

PHOTO N° 0711461



PHOTO N° 0711462

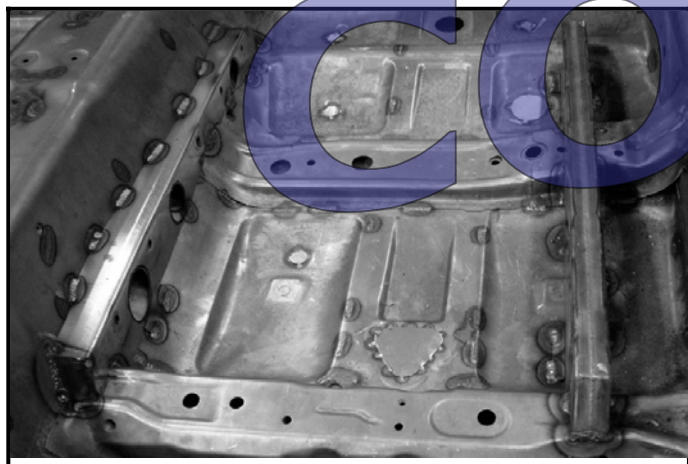

PHOTO N° 0711463

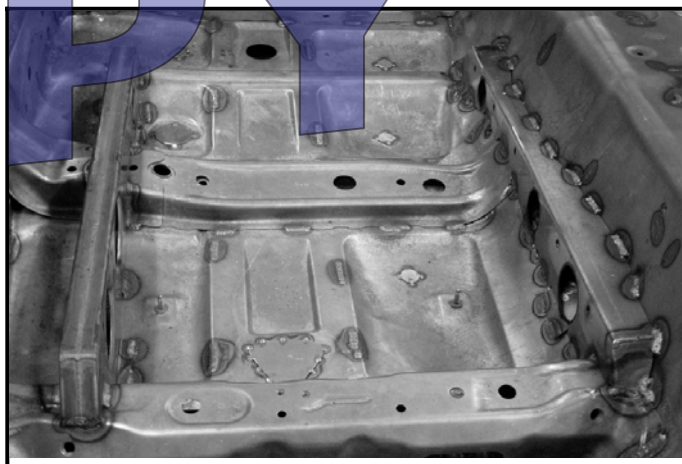

PHOTO N° 0711464

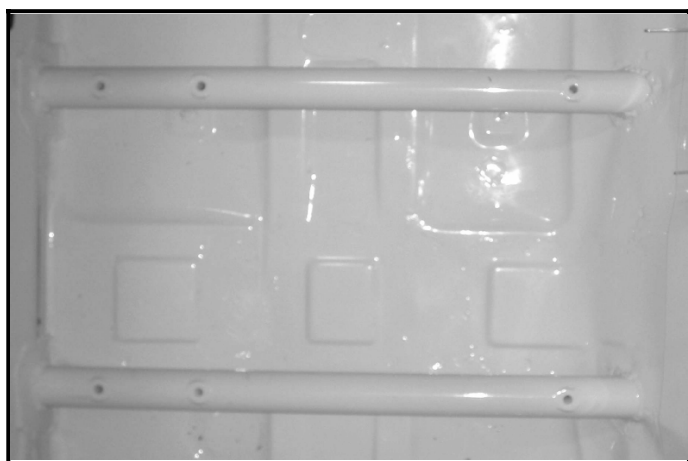

PHOTO N° 0711465



Fédération Internationale de l'Automobile  
Chemin de Blandonnet, 2.  
CH-1215 GENEVE 15  
Tel.: 41 22 544 44 00  
Fax Sport: 41 22 544 44 50

Marque  
Make  
会社名 **FUJI**

Modèle  
Model  
モデル **GRB**

Homologation N°

**N-5714**

Extension N°

**01/01 VO**

JAF公認番号

**FN-085 VO-1/1**

PHOTO N° 0711466



PHOTO N° 0711467

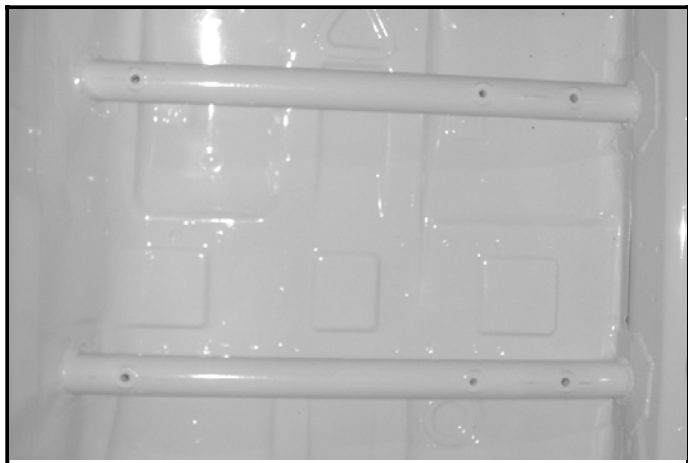

PHOTO N° 0711468

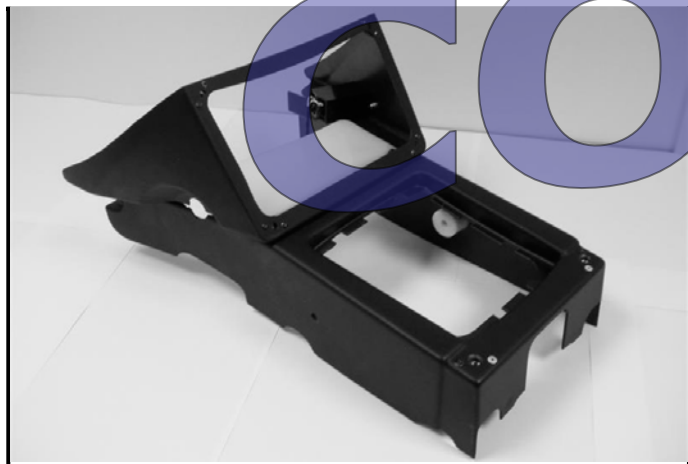

PHOTO N° 0711469



PHOTO N° 0711470



PHOTO N°



Fédération Internationale de l'Automobile  
Chemin de Blandonnet, 2  
CH-1215 GENEVE 15  
Tel.: 41 22 544 44 00  
Fax Sport: 41 22 544 44 50



Marque  
Make  
会社名 **FUJI**

Modèle  
Model  
モデル **GRB**

Homologation N°

**N-5714**

Extension N°

**01/01 VO**

JAF公認番号

**FN-085 VO-1/1**

**FICHE D'HOMOLOGATION VO POUR FREINS A DISQUE (à utiliser avec première page de "Fiche d'Extension d'Homologation")**  
**VO HOMOLOGATION FORM FOR DISC BRAKES (to be used with first page of "Form of Homologation Extension")**

ディスクブレーキのVO公認書式 (追加公認書式の最初のページと共に使用)

**803. Freins**  
**Brakes** ブレーキ

e) Nombre de cylindres par roue  
Number of cylinders per wheel 1ホイール当りのシリンダー数

e1) Alésage  
Bore ボア

**g) Freins à disques**  
**Disc brakes** ディスクブレーキ

g1) Nombre de plaquettes par roue  
Number of pads per wheel 1ホイール当りのパッドの数

g2) Nombre d'étriers par roue  
Number of calipers per wheel  
1ホイール当りのキャリパーの数

g3) Matériau des étriers  
Caliper material キャリパーの材質

g4) Epaisseur du disque neuf  
Thickness of new disc 新品ディスクの厚さ

g5) Diamètre extérieur du disque  
External diameter of the disc ディスクの外径

g6) Diamètre extérieur de frottement des plaquettes  
External diameter of pads' rubbing surface  
パッド摩擦面の外径

g7) Diamètre intérieur de frottement des plaquettes  
Internal diameter of pads' rubbing surface  
パッド摩擦面の内径

g8) Longueur hors-tout des plaquettes  
Overall length of the pads パッドの全長

g9) Disques ventilés  
Ventilated discs ベンチレーテッドディスク

	Avant / Front / 前	Arrière / Rear / 後
e)	<b>4</b>	<b>4</b>
e1)	<b>34.93 / 41.28</b> mm	<b>26.99 / 34.00</b> mm
g1)	<b>2</b>	<b>2</b>
g2)	<b>1</b>	<b>1</b>
g3)	<b>ALUMINIUM ALLOY</b>	<b>ALUMINIUM ALLOY</b>
g4)	××× +/- 1 mm	××× +/- 1 mm
g5)	××× +/- 1.5 mm	××× +/- 1.5 mm
g6)	××× +/- 1.5 mm	××× +/- 1.5 mm
g7)	××× +/- 1.5 mm	××× +/- 1.5 mm
g8)	<b>131.3</b> +/- 1.5 mm	<b>131.5</b> +/- 1.5 mm
g9)	<input type="checkbox"/> oui yes 有	<input type="checkbox"/> non no 無

PHOTO N° **0711450**

Avant / Front / 前



PHOTO N° **0711456**

Arrière / Rear / 後



Fédération Internationale de l'Automobile  
Chemin de Blandonnet, 2  
CH-1215 GENEVE 15  
Tél.: 41 22 544 44 00  
Fax Sport: 41 22 544 44 50

Marque  
Make  
会社名 **FUJI**

Modèle  
Model  
モデル **GRB**

Homologation N°

**N-5714**

Extension N°

**01/01 VO**

JAF公認番号

**FN-085 VO-1/1**

**FICHE D'HOMOLOGATION VO POUR FREINS A DISQUE (à utiliser avec première page de "Fiche d'Extension d'Homologation")**  
**VO HOMOLOGATION FORM FOR DISC BRAKES (to be used with first page of "Form of Homologation Extension")**

ディスクブレーキのVO公認書式 (追加公認書式の最初のページと共に使用)

**803. Freins**  
**Brakes** ブレーキ

e) Nombre de cylindres par roue  
Number of cylinders per wheel 1ホイール当りのシリンダー数

× × ×

× × ×

e1) Alésage  
Bore ボア

× × × mm

× × × mm

**g) Freins à disques**  
**Disc brakes** ディスクブレーキ

g1) Nombre de plaquettes par roue  
Number of pads per wheel 1ホイール当りのパッドの数

× × ×

× × ×

g2) Nombre d'étriers par roue  
Number of calipers per wheel  
1ホイール当りのキャリパーの数

× × ×

× × ×

g3) Matériau des étriers  
Caliper material キャリパーの材質

× × ×

× × ×

g4) Epaisseur du disque neuf  
Thickness of new disc 新品ディスクの厚さ

**32** +/- 1 mm

**27** +/- 1 mm

g5) Diamètre extérieur du disque  
External diameter of the disc ディスクの外径

**355** +/- 1.5 mm

**285** +/- 1.5 mm

g6) Diamètre extérieur de frottement des plaquettes  
External diameter of pads' rubbing surface  
パッド摩擦面の外径

**355** +/- 1.5 mm

**285** +/- 1.5 mm

g7) Diamètre intérieur de frottement des plaquettes  
Internal diameter of pads' rubbing surface  
パッド摩擦面の内径

**255** +/- 1.5 mm

**197** +/- 1.5 mm

g8) Longueur hors-tout des plaquettes  
Overall length of the pads パッドの全長

× × × +/- 1.5 mm

× × × +/- 1.5 mm

g9) Disques ventilés  
Ventilated discs ベンチレーテッドディスク

oui yes 有  non no 無

oui yes 有  non no 無

PHOTO N° **0711451**

Avant / Front / 前

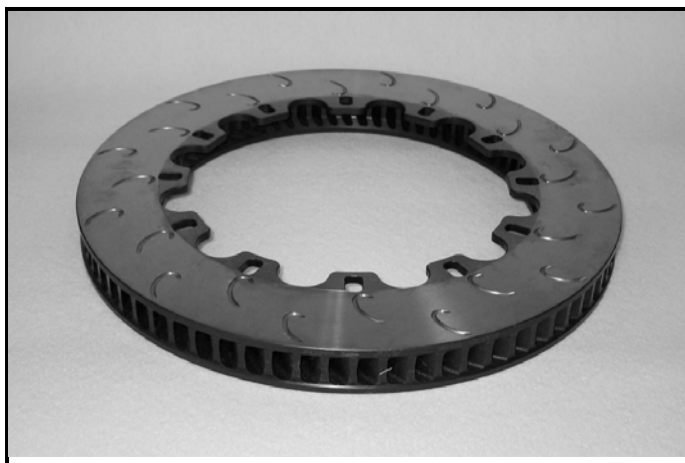

PHOTO N° **0711457**

Arrière / Rear / 後



Fédération internationale de l'Automobile  
Chemin de Blandonnet, 2  
CH-1215 GENEVE 15  
Tél.: 41 22 544 44 00  
Fax Sport: 41 22 544 44 50

Marque  
Make  
会社名 **FUJI**

Modèle  
Model  
モデル **GRB**

Homologation N°

**N-5714**

Extension N°

**01/01 VO**

JAF公認番号

**FN-085 VO-1/1**

**FICHE D'HOMOLOGATION VO POUR FREINS A DISQUE (à utiliser avec première page de "Fiche d'Extension d'Homologation")**  
**VO HOMOLOGATION FORM FOR DISC BRAKES (to be used with first page of "Form of Homologation Extension")**

ディスクブレーキのVO公認書式 (追加公認書式の最初のページと共に使用)

**803. Freins**  
**Brakes** ブレーキ

e) Nombre de cylindres par roue  
Number of cylinders per wheel 1ホイール当りのシリンダー数

× × ×

× × ×

e1) Alésage  
Bore ボア

× × × mm

× × × mm

**g) Freins à disques**  
**Disc brakes** ディスクブレーキ

g1) Nombre de plaquettes par roue  
Number of pads per wheel 1ホイール当りのパッドの数

× × ×

× × ×

g2) Nombre d'étriers par roue  
Number of calipers per wheel  
1ホイール当りのキャリパーの数

× × ×

× × ×

g3) Matériau des étriers  
Caliper material キャリパーの材質

× × ×

× × ×

g4) Epaisseur du disque neuf  
Thickness of new disc 新品ディスクの厚さ

**32** +/- 1 mm

× × × +/- 1 mm

g5) Diamètre extérieur du disque  
External diameter of the disc ディスクの外径

**295** +/- 1.5 mm

× × × +/- 1.5 mm

g6) Diamètre extérieur de frottement des plaquettes  
External diameter of pads' rubbing surface  
パッド摩擦面の外径

**295** +/- 1.5 mm

× × × +/- 1.5 mm

g7) Diamètre intérieur de frottement des plaquettes  
Internal diameter of pads' rubbing surface  
パッド摩擦面の内径

**193.4** +/- 1.5 mm

× × × +/- 1.5 mm

g8) Longueur hors-tout des plaquettes  
Overall length of the pads パッドの全長

× × × +/- 1.5 mm

× × × +/- 1.5 mm

g9) Disques ventilés  
Ventilated discs ベンチレーテッドディスク

oui 有  
 non 無

oui 有  
 non 無

PHOTO N° **0711453**

Avant / Front / 前

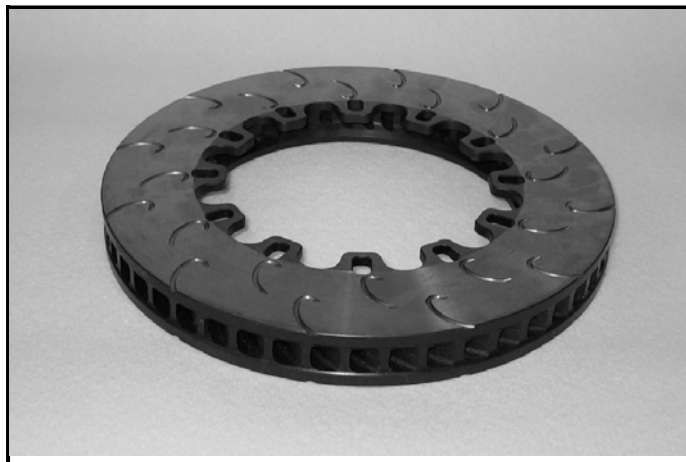

PHOTO N°

Arrière / Rear / 後



Fédération Internationale de l'Automobile  
Chemin de Blandonnet, 2  
CH-1215 GENEVE 15  
Tél.: 41 22 544 44 00  
Fax Sport: 41 22 544 44 50

Marque  
Make  
会社名 **FUJI**

Modèle  
Model  
モデル **GRB**

Homologation N°

**N-5714**

Extension N°

**01/01 VO**

JAF公認番号

**FN-085 VO-1/1**

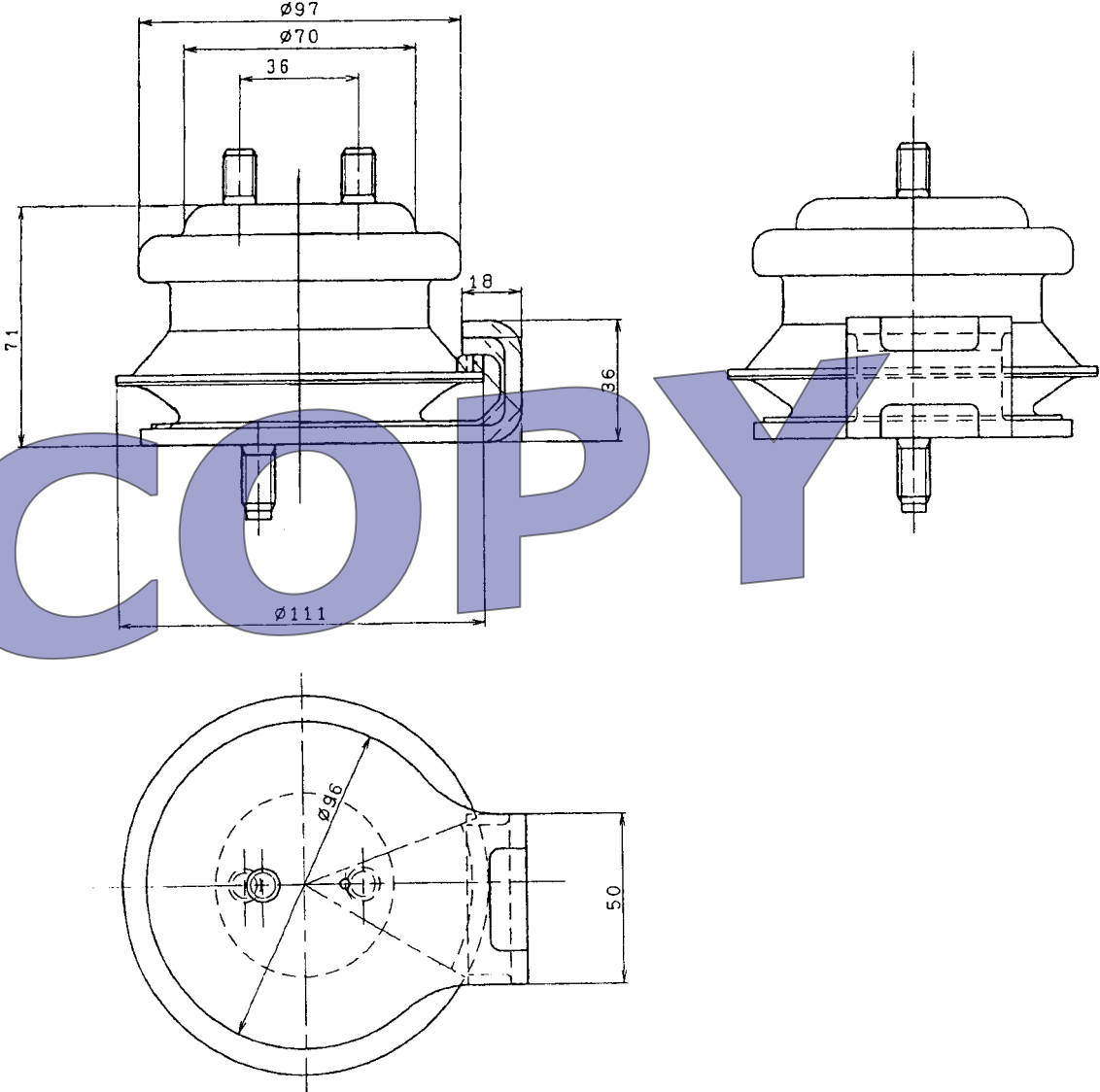
Page or ext. 頁または追加番号	Article 項目	Description 記述
		<p data-bbox="347 517 1449 551"><b>DRAWING 0711971) Engine support dimensions when dismantled tolerance <math>\pm 2\%</math></b></p>  <p data-bbox="308 1003 1034 1279">A large blue 'COPY' watermark is overlaid on the drawing.</p>

Fédération Internationale de l'Automobile

Chemin de Blandonnet, 2

CH-1215 GENEVE 15

Tél.: 41 22 544 44 00

Fax Sport: 41 22 544 44 50

Marque  
Make  
会社名 **FUJI**

Modèle  
Model  
モデル **GRB**

Homologation N°

**N-5714**

Extension N°

**01/01 VO**

JAF公認番号

**FN-085 VO-1/1**

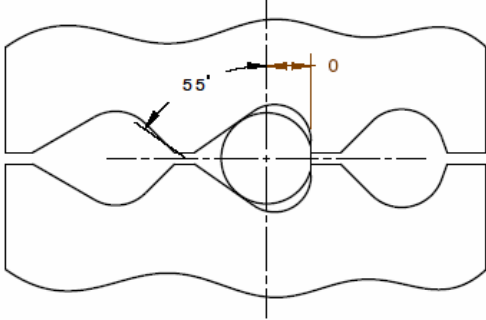
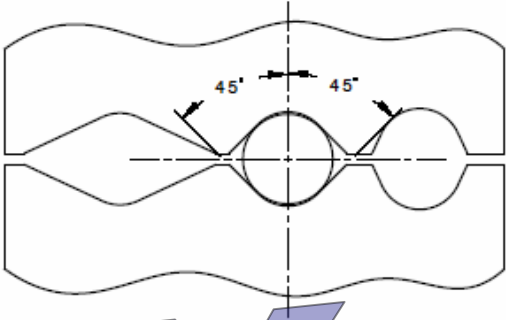
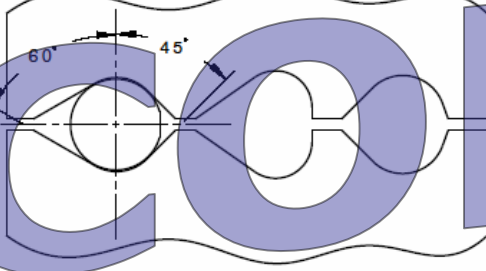
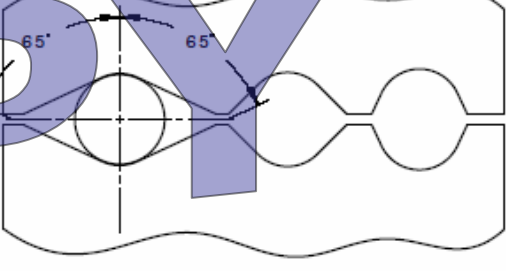
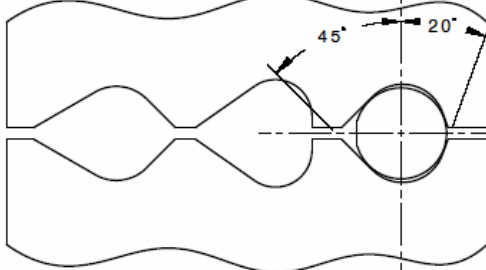
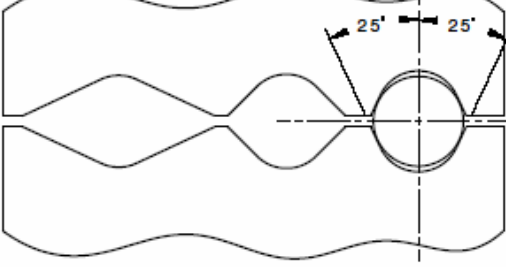
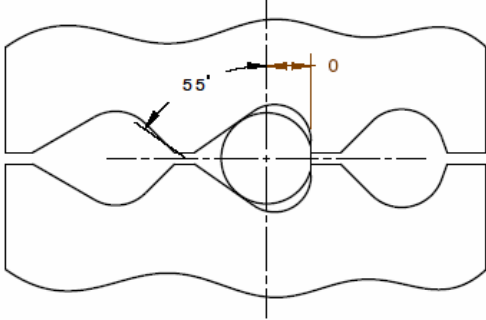
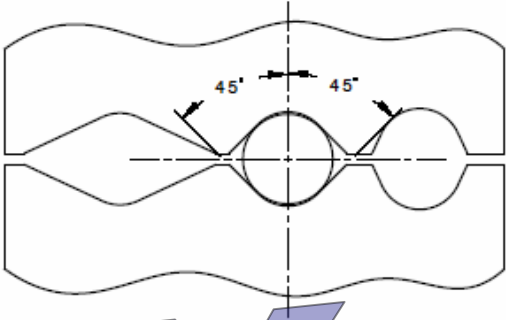
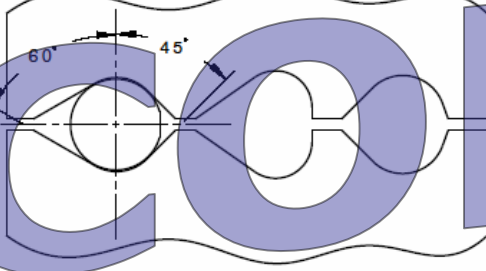
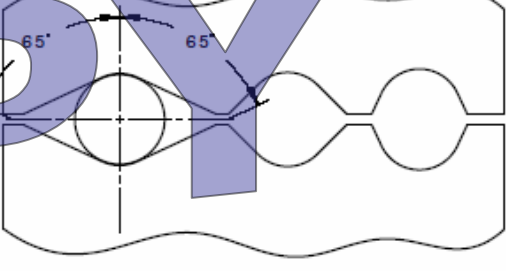
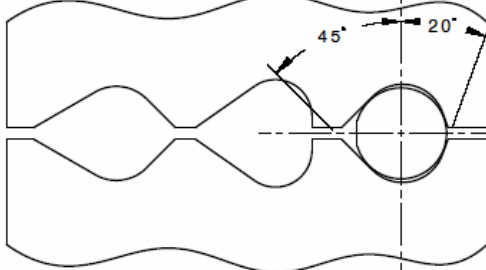
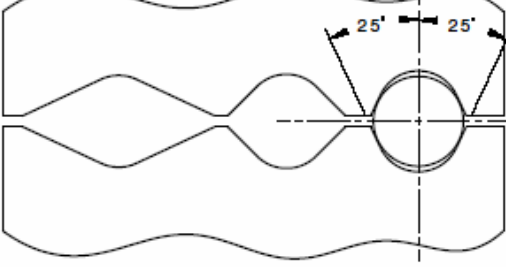
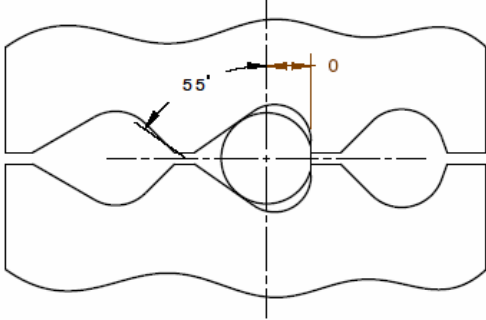
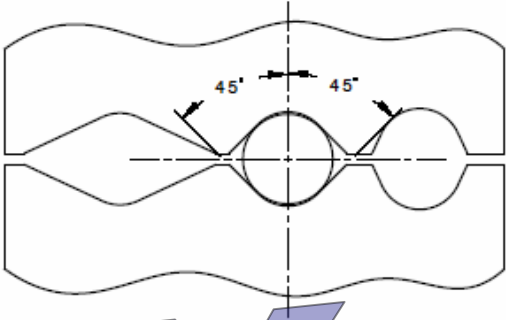
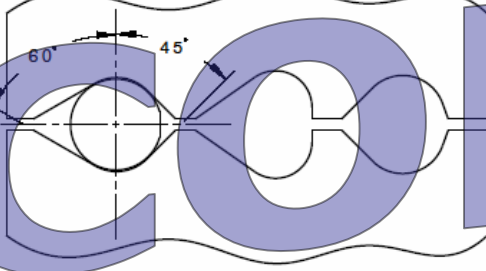
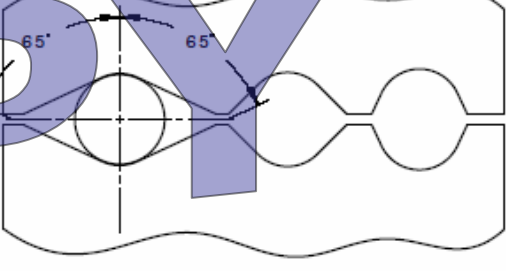
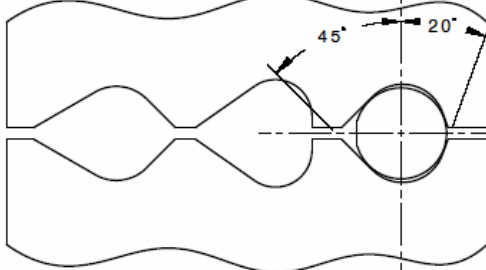
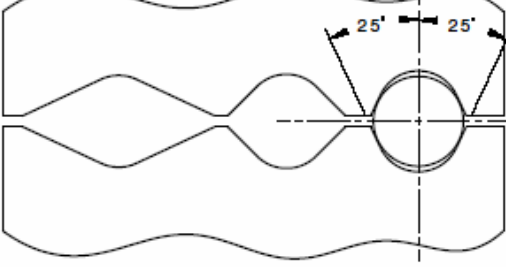
Page or ext. 頁または追加番号	Article 項目	Description 記述								
		<table border="0"><tr><td data-bbox="347 539 863 633"><b>DRAWING 0711972)</b> <b>Front LSD cam angle</b> <b>tolerance <math>\pm 1\%</math></b></td><td data-bbox="922 539 1445 633"><b>DRAWING 0711973)</b> <b>Rear LSD cam angle</b> <b>tolerance <math>\pm 1\%</math></b></td></tr><tr><td></td><td></td></tr><tr><td></td><td></td></tr><tr><td></td><td></td></tr></table>	<b>DRAWING 0711972)</b> <b>Front LSD cam angle</b> <b>tolerance <math>\pm 1\%</math></b>	<b>DRAWING 0711973)</b> <b>Rear LSD cam angle</b> <b>tolerance <math>\pm 1\%</math></b>						
<b>DRAWING 0711972)</b> <b>Front LSD cam angle</b> <b>tolerance <math>\pm 1\%</math></b>	<b>DRAWING 0711973)</b> <b>Rear LSD cam angle</b> <b>tolerance <math>\pm 1\%</math></b>									
										
										
										

**COPY**

Fédération Internationale de l'Automobile  
Chemin de Blondomet, 2  
CH-1215 GENEVE 15  
Tél.: 41 22 544 44 00  
Fax Sport: 41 22 544 44 50

Marque  
Make  
会社名 **FUJI**

Modèle  
Model  
モデル **GRB**

Homologation N°

**N-5714**

Extension N°

**01/01 VO**

JAF公認番号

**FN-085 VO-1/1**

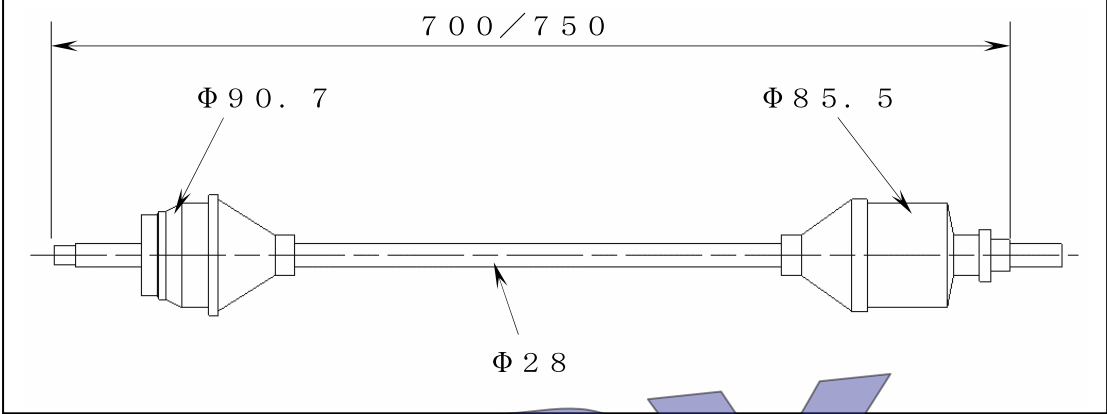
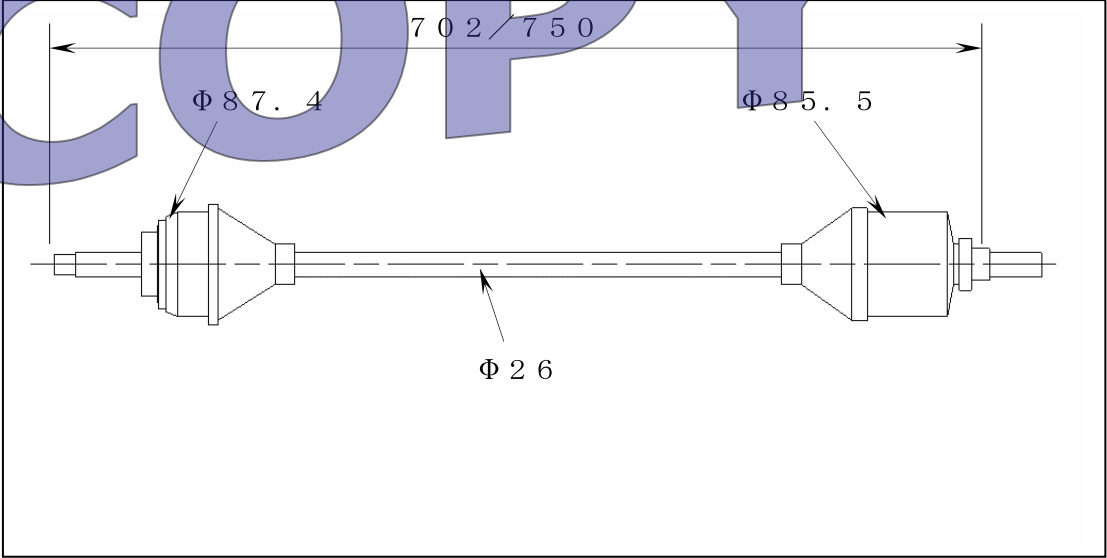
Page or ext. 頁または追加番号	Article 項目	Description 記述
		<p><b>DRAWING 0511974) Front transversal half-shafts, type 2NF tolerance <math>\pm 1\%</math></b></p>  <p><b>DRAWING 0511975) Rear transversal half-shafts, type 2NR tolerance <math>\pm 1\%</math></b></p> 

Fédération Internationale de l'Automobile  
Chemin de Blondomet, 2  
CH-1215 GENEVE 15  
Tél.: 41 22 544 44 00  
Fax Sport: 41 22 544 44 50



**N-5714**

**01/01 VO**

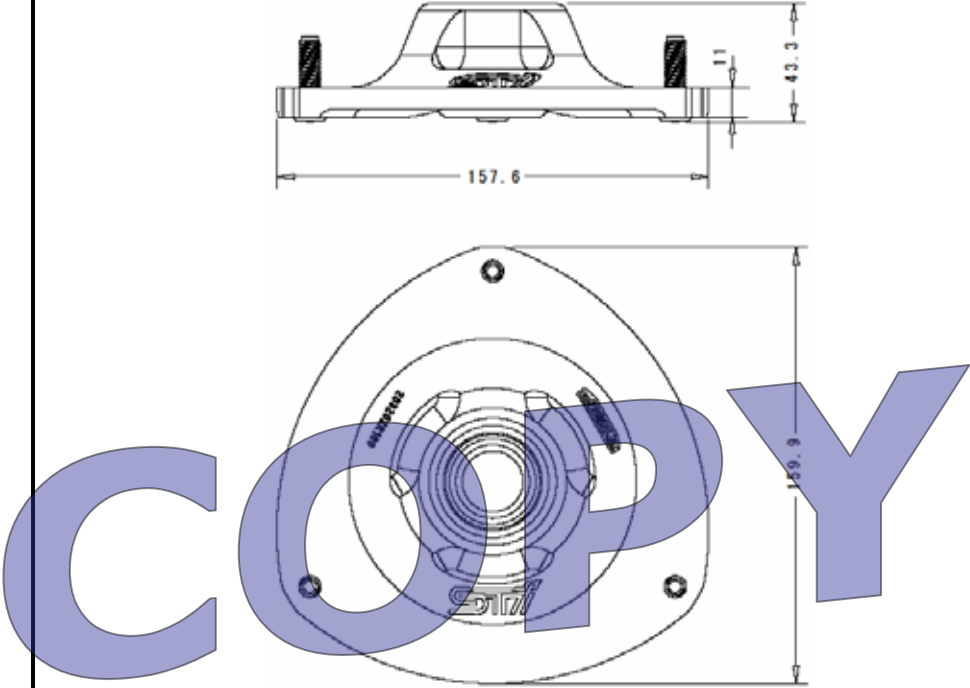
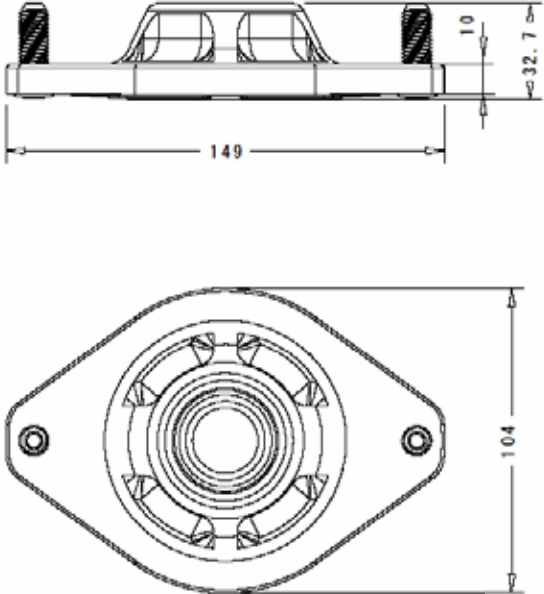
Page or ext. 頁または追加番号	Article 項目	Description 記述
		<p><b>DRAWING 0711976) Suspension, Front top mount plate tolerance ±1%</b></p>  <p><b>DRAWING 0711977) Suspension, Rear top mount plate tolerance ±1%</b></p> 

**N-5714**

**01/01 VO**

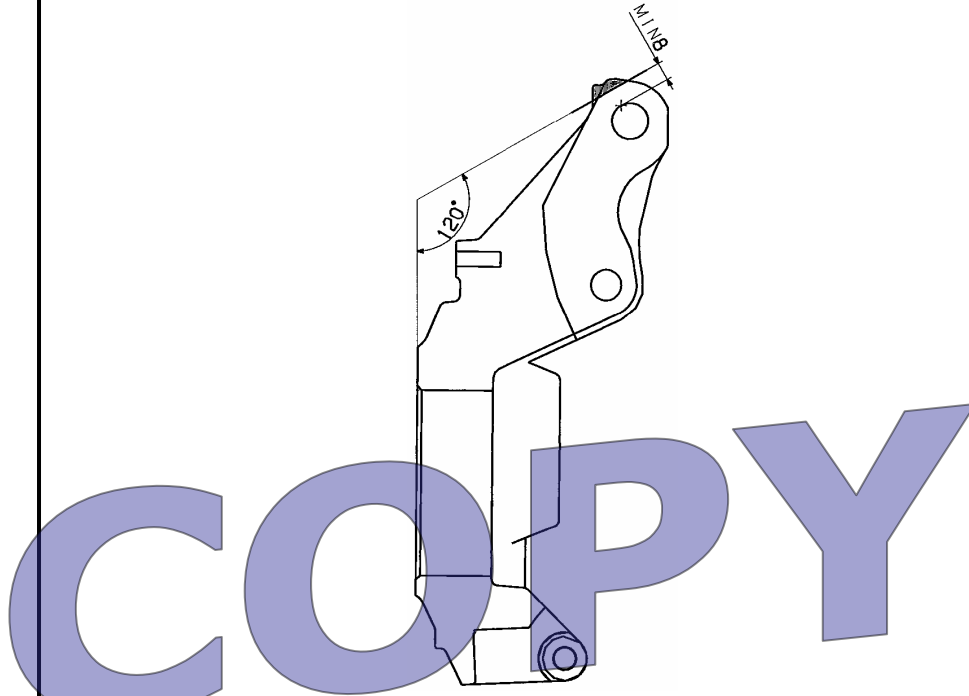
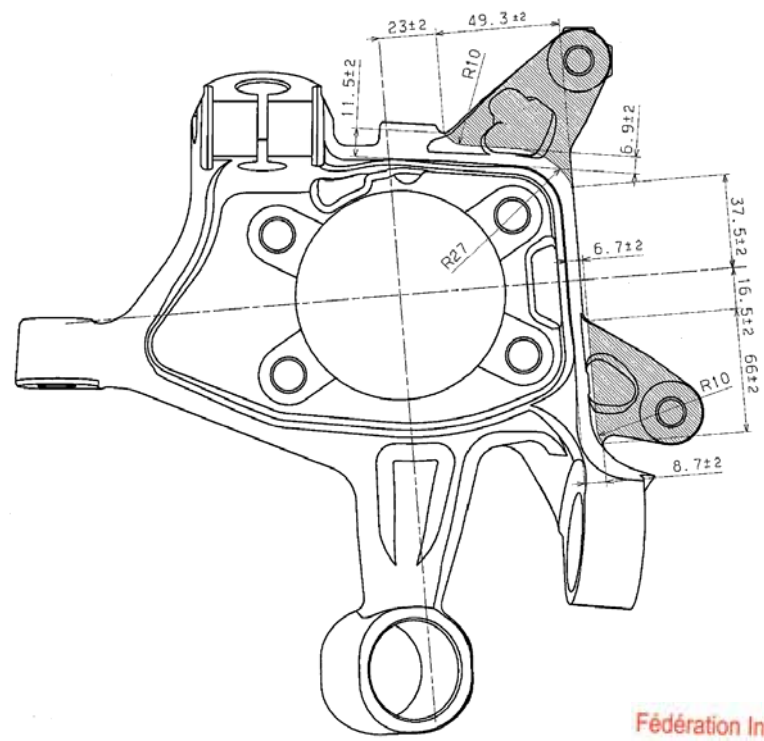
Page or ext. 頁または追加番号	Article 項目	Description 記述
		<p><b>DRAWING 0711978) Modification for front upright</b>      tolerance <math>\pm 1\%</math></p>  <p><b>DRAWING 0711979) Modification for rear upright</b>      tolerance <math>\pm 1\%</math></p>  <p>Fédération Internationale de l'Automobile Chemin de Blandonnet, 2 CH-1215 GENEVE 15 Tél.: 41 22 544 44 00 Fax Sport: 41 22 544 44 50</p>

Marque  
Make  
会社名 **FUJI**

Modèle  
Model  
モデル **GRB**

Homologation N°

**N-5714**

Extension N°

**01/01 VO**

JAF公認番号

**FN-085 VO-1/1**

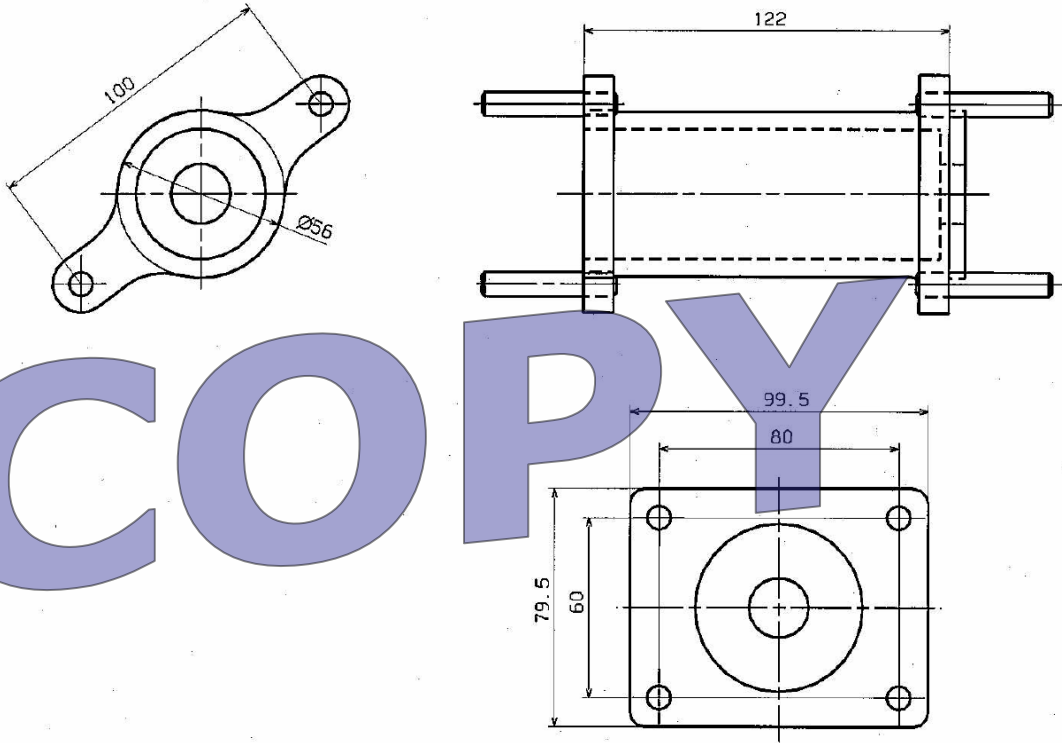
Page or ext. 頁または追加番号	Article 項目	Description 記述
		<p data-bbox="347 539 1153 573"><b>DRAWING 0711980) Master cylinder spacer tolerance <math>\pm 1\%</math></b></p>  <p data-bbox="308 1016 1278 1272"><b>COPY</b></p>

Fédération Internationale de l'Automobile  
Chemin de Blondonnet, 2  
CH-1215 GENEVE 15  
Tél.: 41 22 544 44 00  
Fax Sport: 41 22 544 44 50

**N-5714**

**01/01 VO**

Page or ext. 頁または追加番号	Article 項目	Description 記述
		<p><b>DRAWING 0711981) Braking regulator system, when using standard hand brake system</b></p> <p><b>DRAWING 0711982) Braking regulator with hydraulic parking brake system</b></p> <p><b>DRAWING 0511983) Hydraulic parking brake control system</b></p>

Marque  
Make  
会社名 **FUJI**

Modèle  
Model  
モデル **GRB**

Homologation N°

**N-5714**

Extension N°

**01/01 VO**

JAF公認番号

**FN-085 VO-1/1**

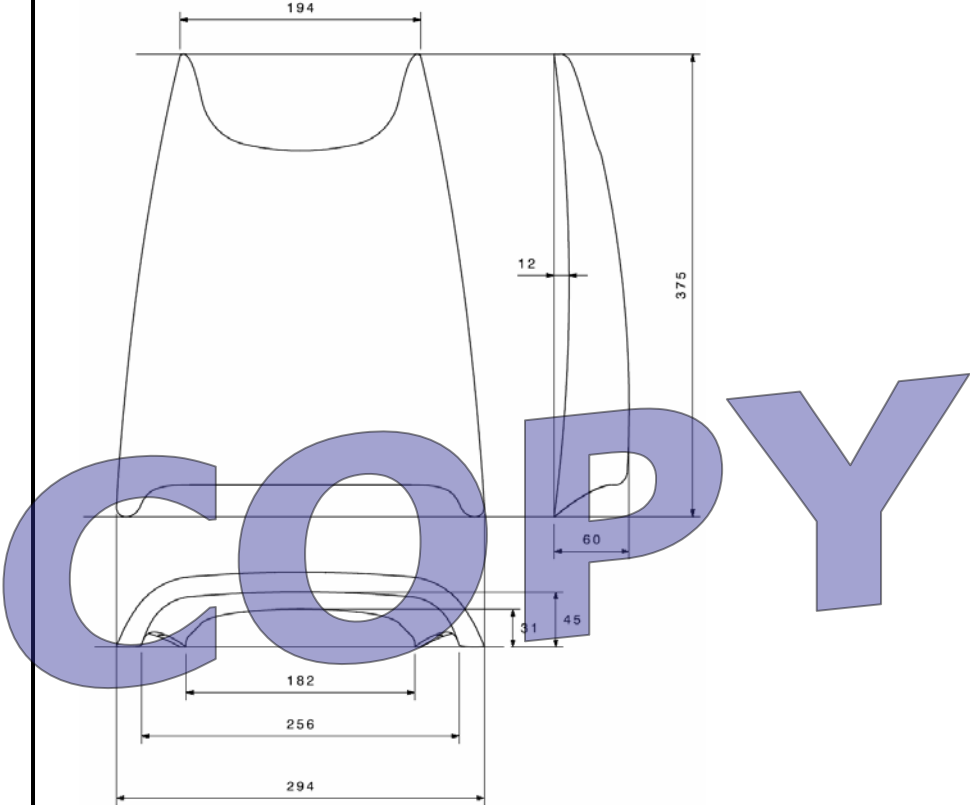
Page or ext. 頁または追加番号	Article 項目	Description 記述
		<p><b>DRAWING 0711984) Roof ventilator tolerance <math>\pm 5\%</math></b></p>  <p>The drawing shows a roof ventilator with the following dimensions: top width 194, total height 375, a small offset of 12, a base width of 60, a base height of 45, and a small offset of 31. Horizontal dimensions at the base are 182, 256, and 294.</p> <p><b>COPY</b></p>

Fédération Internationale de l'Automobile  
Chemin de Blondonnet, 2  
CH-1215 GENEVE 15  
Tél.: 41 22 544 44 00  
Fax Sport: 41 22 544 44 50